



Prevail

Available Finish:

- Amber Cherry

Options:

All available options on Kwik Office models are listed on the individual pricing pages.

Statement of Line

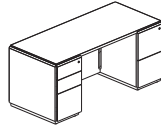

Desks

- Double pedestal
 - Single pedestal
 - Extended single pedestal
- See page 8.

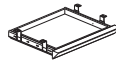

Center Drawer

- See page 8.

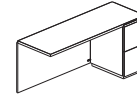

Returns

- File/file pedestal
 - Multi-file pedestal
- See page 9.

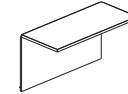

Bridges

- See page 9.

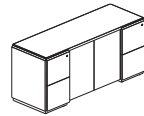

Credenzas

- Storage
 - Kneespace
 - File/file pedestal
 - Lateral file pedestal
- See pages 9–10.

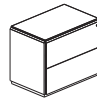

Lateral Files

- Two drawer
- See page 10.

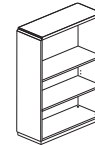

Bookcases

- Two shelves
 - Four shelves
- See page 11.

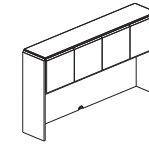

Highback Organizers

- Wood doors
- See page 11.



Tackboard

- For use with highback organizer
- See page 11.



Overhead Storage

- Wood doors
- See page 12.



Wall Mount Brackets

- For overhead storage
- See page 12.

➤ See page

Overview	5
Technology Management	6
Filing Capabilities	7



Prevail

Overview

Chamfer Detail:

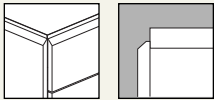

Grommets:



Worksurface grommets are available factory installed on certain models.

- See pricing pages for availability.
- See page 6 for grommet locations.

Worksurfaces are 1³/₁₆"-thick, 3-ply, balanced construction with a solid wood rim.

Chamfered end panels encapsulate the worksurface, giving Prevail its distinct design.

Hinged access doors for cable routing are located on the approach side of all desks.

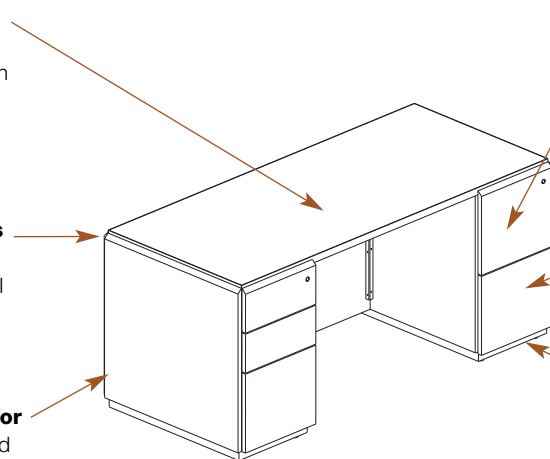

Drawer fronts are 3/4"-thick, 3-ply construction with vertically matched grain. 5-sided drawer construction allows easy removal of drawer fronts.

Pedestals are full height and letter width.

Plinth base with adjustable levelers is standard on all Prevail casegoods. Base is banded with ABS for durability in a platinum finish.

Details

Exterior surfaces are available in cherry veneer. Veneers are carefully selected and matched to assure proper balance and consistency.

Worksurfaces are wood.

Joints are securely fastened with screws, glue, and solid hardwood cleats to ensure maximum strength.

Drawer sides and back are 1/2" thick and wrapped in black vinyl. Bottoms are 1/8" thick.

Drawer suspensions feature black slides with precision steel ball bearings to ensure long-lasting, quiet, smooth operation. Box drawers are 3/4 extension. File drawers are full extension.

Black filing rods are standard in all file drawers and accommodate various filing requirements.

- See page 7 for filing capabilities.

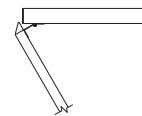

Hinged modesty panels are standard on bridges, returns, kneespace credenzas, and single-pedestal credenzas. A latch holds modesty panel in place.

Pulls:

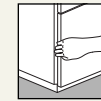

Integral pulls (33) are located on the kneespace side of pedestals

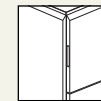

Integral pulls on freestanding lateral files are notched areas (finger pulls) on both sides of each drawer front.

Locks:

Face-mounted locks are standard on all desks, credenzas, returns, and lateral files. Lock cylinders are shipped installed on Kwik Office models and are keyed randomly. Key numbers will be assigned arbitrarily at the factory with key numbers ranging from KCCB001 to KCCB025.



Half-Round Cord Openings:

Desks, credenzas, and returns feature a half-round cord opening in the side of each pedestal just below the worksurface in the kneespace or storage area.



Credenzas feature three additional half-round cord openings along the back.

Worksurface Grommets:

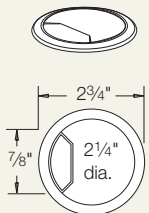

Worksurface grommets (G1) are standard on single pedestal desks, bridges, returns, and credenzas. They are plastic with a matte black finish.

Half-round cord openings for routing cords and cables are standard on all desks, returns, and credenzas.

Hinged modesty panel is standard on bridges, returns, kneespace credenzas, and single pedestal credenzas. It swings inward to allow access to wall outlets.

Opening below hinged access door allows cord to enter or exit the cable routing compartment on the approach side.

Security panel separates the drawers from the cable routing compartment to prevent unwanted access to the drawer contents.

Note: Some of the items in this illustration, including undersurface wire manager, power communication convenience outlet, panel grommets, and executive return with printer pedestal, are available at standard lead times.

➤ See the Casegoods and Tables Price List.

Hinged access doors allow access to cable routing compartment. Both single- and double-pedestal desks feature two access doors, one on the left and one on the right on the approach side.

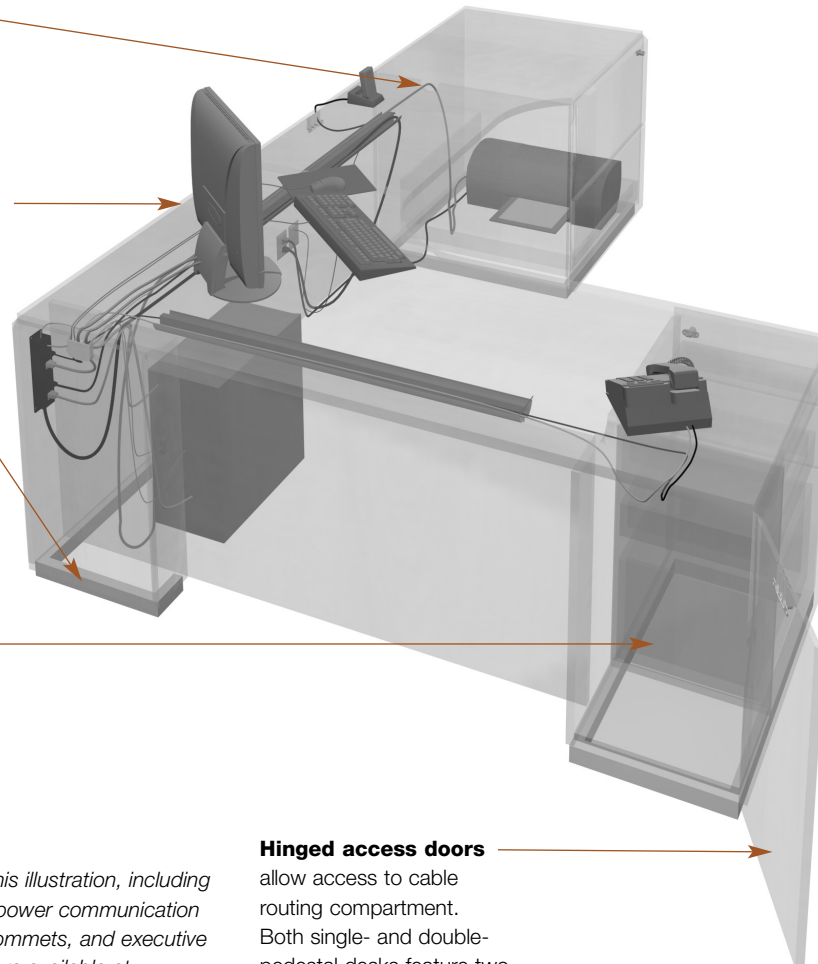

Grommet Locations:

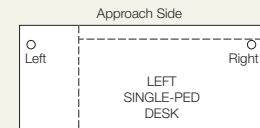

Single pedestal desks are standard with worksurface grommets on both left and right.

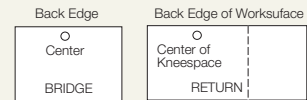

Bridges and returns are standard with one worksurface grommet, centered in the kneespace.

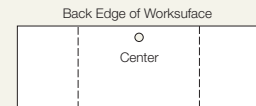

Kneespace credenzas and file/file single pedestal credenzas are standard with one worksurface grommet, centered in the kneespace.

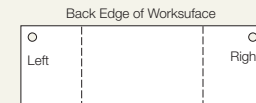

Storage credenzas and lateral file single pedestal credenzas are standard with worksurface grommets on both left and right along the back edge.



Filing Capabilities

Filing Reference:

- Legal size paper is 8½" x 14".
- Letter size paper is 8½" x 11".
- EDP size paper is 8½" x 14⁷/₈".

<i>Description</i>	<i>Type</i>	Interior Dimensions			Standard Filing Capabilities	
		<i>Inside Depth</i>	<i>Inside Width</i>	<i>Inside Height</i>	<i>Front-to-Back</i>	<i>Side-to-Side</i>
Desks						
Double pedestal	Box	17"	12"	21½"	—	—
	File	17"	12"	9"	Letter	Legal, letter, and EDP
Single pedestal	Box	17"	12"	21½"	—	—
	File	17"	12"	9"	Letter	Legal, letter, and EDP
Returns						
File/file pedestal	File	17"	12"	9"	Letter	Legal, letter, and EDP
Multi-file pedestal	Box	17"	12"	21½"	—	—
	File	17"	12"	9"	Letter	Legal, letter, and EDP
	Lateral	15"	27½"	9"	Legal, letter, and EDP	Legal, letter, and EDP
Credenzas						
Storage, kneespace, and file/file single pedestal	File	17"	12"	9"	Letter	Legal, letter, and EDP
Lateral file single pedestal	Lateral	15"	26¼"	9"	Legal, letter, and EDP	Legal, letter, and EDP
Lateral files	Lateral	15"	32 ³ / ₈ "	9"	Legal, letter, and EDP	Legal, letter, and EDP
Center drawers	Center	17"	20¼"	1½"	—	—



How to Specify and Pricing, continued

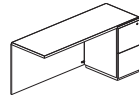

Returns with FF Pedestal

- Wood worksurface
- Modesty panel
- Lock, key random
- Black center worksurface grommet
- Platinum plinth base
- Integral pulls

How to Specify:

- ① Model:
Q22K2450R = 24" x 50"
- ② Pedestal location:
REF = Right (shown)
LEF = Left
- ③ Worksurface material:
W2 = Wood
- ④ Finish designator:
MC = Amber Cherry

Sample (base model underlined):

Q22K2450R^①^②^③^④REFW2MC

Pricing:

Q22K2450R \$1600

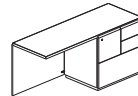

Returns with Multi-File Ped

- Wood worksurface
- Modesty panel
- Lock, key random
- Black center worksurface grommet
- Platinum plinth base
- Integral pulls

How to Specify:

- ① Model:
Q22K2465R = 24" x 65"
- ② Pedestal location:
REF = Right (shown)
LEF = Left
- ③ Worksurface material:
W10 = Wood
- ④ Finish designator:
MC = Amber Cherry

Sample (base model underlined):

Q22K2465R^①^②^③^④REFW10MC

Pricing:

Q22K2465R \$2154

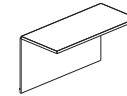

Bridges

- Wood worksurface
- Modesty panel
- Black center worksurface grommet

How to Specify:

- ① Model:
Q22K2342BEFH = 23" x 42"
Q22K2349BEFH = 23" x 49"
- ② Worksurface material:
W = Wood
- ③ Finish designator:
MC = Amber Cherry

Sample (base model underlined):

Q22K2342BEFH^①^②^③LWMC

Pricing:

Q22K2342BEFH \$639
Q22K2349BEFH \$694

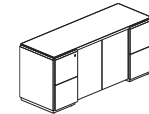

Storage Credenzas

- Wood worksurface
- Two FF pedestals
- Center storage
- One lock per pedestal, key random
- Black left & right wksf. grommets
- Platinum plinth base
- Integral pulls

How to Specify:

- ① Model:
Q22K2372CSFW2 = 23" x 72"
- ② Finish designator:
MC = Amber Cherry

Sample (base model underlined):

Q22K2372CSFW2^①^②MC

*Exception: **GSA SIN 711-9**

Pricing:

Q22K2372CSFW2 \$2464



How to Specify and Pricing, continued

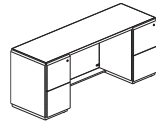

Knespace Credenzas

- Wood worksurface
- Two FF pedestals
- One lock per pedestal, key random
- Black center worksurface grommet
- Platinum plinth base
- Integral pulls

How to Specify:

- ① Model:
Q22K2372CKFW2 = 23" x 72"
- ② Finish designator:
MC = Amber Cherry

Sample (base model underlined):

① ②
Q22K2372CKFW2MC

Pricing:

Q22K2372CKFW2 \$2318

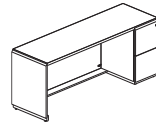

Single-Pedestal Credenzas

- Wood worksurface
- FF pedestal
- Lock, key random
- Black center worksurface grommet
- Platinum plinth base
- Integral pulls

How to Specify:

- ① Model:
Q22K2372C = 23" x 72"
- ② Pedestal location:
RF = Right (shown)
LF = Left
- ③ Worksurface material:
W2 = Wood
- ④ Finish designator:
MC = Amber Cherry

Sample (base model underlined):

① ② ③ ④
Q22K2372CRFW2MC

Pricing:

Q22K2372C \$1880

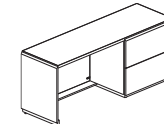

Lateral File Credenzas

- Wood worksurface
- Lateral file
- Lock, key random
- Black left & right wksf. grommets
- Platinum plinth base
- Integral pulls

How to Specify:

- ① Model:
Q22K2372C = 23" x 72"
- ② Pedestal location:
RF = Right (shown)
LF = Left
- ③ Worksurface material:
W6 = Wood
- ④ Finish designator:
MC = Amber Cherry

Sample (base model underlined):

① ② ③ ④
Q22K2372CRFW6MC

Pricing:

Q22K2372C \$2287

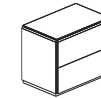

Lateral Files

- Wood worksurface
- Two drawers
- Platinum plinth base
- Integral pulls

How to Specify:

- ① Model:
Q22K2336LFF2W = 23" x 36"
- ② Finish designator:
MC = Amber Cherry

Sample (base model underlined):

① ②
Q22K2336LFF2WMC

Pricing:

Q22K2336LFF2W \$1423



Prevail

How to Specify and Pricing, continued

Related Products:

- Task lights
- See page 24.

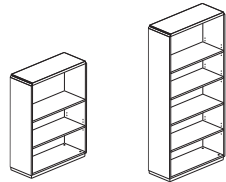

Bookcases

- Two or four open shelves
- Unfinished back
- Platinum plinth base

How to Specify:

- ① Model:
Q22K3442BCOW = 34" x 42"
 (two-shelf model)
Q22K3469BCOW = 34" x 69"
 (four-shelf model)
- ② Finish designator:
MC = Amber Cherry

Sample (base model underlined):

① ②
Q22K3442BCOWMC

Pricing:

Q22K3442BCOW	\$1022
Q22K3469BCOW	\$1557

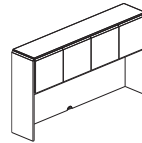

Highback Organizers

- Wood doors
- Integral pulls

How to Specify:

- ① Model:
Q22K7040HBHW = 70" x 40"
- ② Finish designator:
MC = Amber Cherry

Sample (base model underlined):

① ②
Q22K7040HBHWMC

Pricing:

Q22K7040HBHW	\$2128
---------------------	--------



Tackboard

- Terra Plus 3413 Stone upholstery
- 69" x 16"
- For use with highback organizer

How to Specify:

- ① Model:
Q22K6916TBK3413

Sample (base model underlined):

①
Q22K6916TBK3413

Pricing:

Q22K6916TBK3413	\$448
------------------------	-------



How to Specify and Pricing, continued



Overhead Storage

- Wood doors
- Integral pulls
- Wall-mount brackets required; specify separately

How to Specify:

- ① Model:
Q22K3518SOHMMW = 35" x 18"
- ② Finish designator:
MC = Amber Cherry

Sample (base model underlined):

① ②
Q22K3518SOHMMWMC

Pricing:

Q22K3518SOHMMW \$1003



Wall-Mount Brackets for Overhead Storage

- For overhead storage

How to Specify:

- ① Model:
Q22K68WMB = 68"W
Q22K98WMB = 98"W

Sample (base model underlined):

①
Q22K68WMB

Pricing:

Q22K68WMB \$66
Q22K98WMB \$79