

Statement of Line

Designed for Kimball

Office by David Allan

Pesso, Delano

harmonizes wood, metal,

and tailored cushions in

a contemporary,

architectural approach.

There are one-, two- and

three-seat models,

tables, a bench, and an

ottoman. Versatile

configurations are

possible with tandem

seating units, in-line

tables, storage tables

and tablet arms.

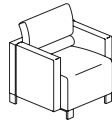

Lounge Seating with Arms

Available in 3-seat, 2-seat, and 1-seat models.

▶ See page 74 to specify.



Lounge Seating without Arms

Available in 3-seat, 2-seat, and 1-seat models.

▶ See page 74 to specify.

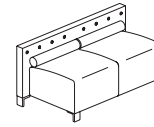

Bench

Available in 3-seat and 2-seat models.

▶ See page 75 to specify.



Ottoman

▶ See page 75 to specify.

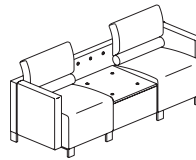

Tandem Seating with Arms

Available with center, center storage, end, or end storage in-line table.

▶ See pages 76–79 to specify.

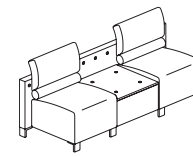

Tandem Seating without Arms

Available with center, center storage, end, or end storage in-line table.

▶ See pages 76–79 to specify.

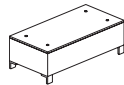

Freestanding Tables

Available in rectangular magazine table and square end table models.

▶ See page 81 to specify.

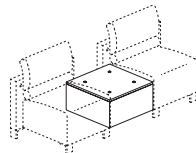

Configurable In-Line Tables

Available in center, end, center storage, end storage, 90° and 45° models.

▶ See page 82 to specify.

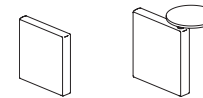

Arms and Tablet Arms

Available for field installation.

▶ See page 80 to specify.

▶ See page

Finishes & Materials 211

Overview 70

Actual Dimensions 73

Delano

Overview

Lounge Seating Design Variations:

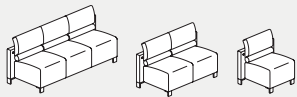

3-Seat 2-Seat 1-Seat

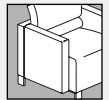

With Arms

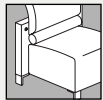

Without Arms

Lounge seating is available in 3-, 2-, and 1-seat models, each with or without factory-installed arms. Arms are also available for field installation.

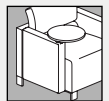

Tablet arm is available factory installed or for field installation. Wood tablet surface is standard; black thermofoil surface is available as an option.

Wall is constructed of 3/4" MDF and attached to the arms/backs using black 5/16" diameter, socket head bolts inserted through a decorative brushed aluminum washer.

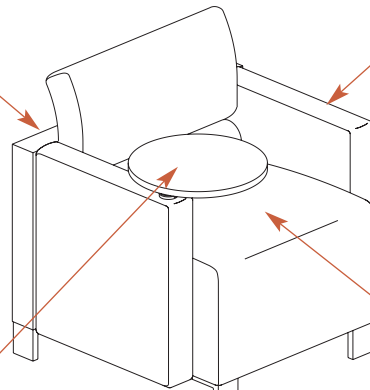

15" writing surface on tablet arm swivels 180°. Tablet mounts to a mechanism that fits into the structure of the tablet arm. Tablet is 3/4" plywood with a wood veneer or black thermofoil writing surface.

Non-skid glides are 3/4" in diameter and adjustable.

Arm frames are constructed of 3/4" plywood, wrapped with 1/4" foam (foam is covered with 1/2 ounce of polyester on top of arm for added comfort), slipcovered, and attached to both the frame and the wall.

Cushions are high grade resiliency, CFC-free polyurethane foam.

Legs are solid aluminum and finished with a natural, brushed finish.

Tandem Seating Design Variations:



In-Line or Storage Table, Center



In-Line End or Storage Table, Right (as seated)

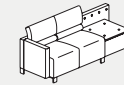

In-Line End Table or Storage Table, Left (as seated)

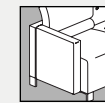

With Arms

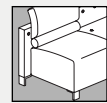

Without Arms

Tandem seating is available with or without arms.

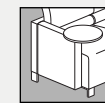

Tablet arm is available factory installed or for field installation.

Freestanding Tables Design Variations:

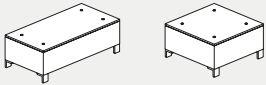

Rectangular
Magazine

Square
End

Freestanding tables are available in two design.

Features

Frame is constructed of 3/4" plywood and attached to the wall. Frame construction meets or exceeds ANSI/BIFMA x5.4-1997, Lounge Seating Test Standard.

Back is constructed of 9/16" plywood.

Back cushions are 2" high-grade polyurethane foam wrapped with 1/2 oz. of polyester. Each cushion is 24"W and upholstered using a slipcover-style upholstery method.

Seats have a high tension strip webbing suspension that is stapled to the frame.

Seat cushions are 3 1/2" high-grade polyurethane foam that is custom shaped. Each cushion is 24"W and upholstered using a slipcover-style upholstery method.

Bolster is 4 1/2" foam, wrapped with 1/2 oz. polyester, slipcovered and closed with a zipper. The bolster is attached to the back of the seat box.

All seating models are fully upholstered. Bottom is finished with a black fabric dust cover.

Tables are constructed of 3/4" plywood. Corners are mitered, then glued and cleated together. Tops on rectangular and square tables are 3/4" plywood with quarter-cut sketch veneer and a non-rubbed finish. Tops on side and 45-degree tables are 3/4" plywood with plain-sliced book-matched veneer and a non-rubbed finish.

Storage tables feature a pull-out drawer. Drawer sides have a 1/2" flakeboard core with a maple veneer face and back. Drawer bottom is 7/32" 5-ply construction with a maple face and maple/birch back. Drawer fronts have a 3/4" flakeboard core with a grade 1 veneer face and grade 2 veneer back. Fronts are fastened to the drawer with washer head (truss) screws. Dowel construction is utilized. Black, progressive-action slides with precision steel ballbearings ensure long lasting, quiet and smooth operation. Slide fully extends (19") and has a 100 lb. load rating.

Locking casters on the mobile table are 4"H.

Configurable Tables Design Variations:

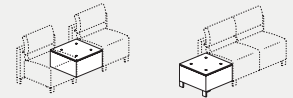

Center In-Line

End In-Line

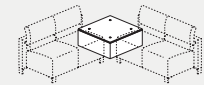

90° In-Line

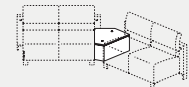

45° In-Line

Configurable tables are available in four designs. Center and end in-line tables are also available as storage tables.

Delano

Configurations and Planning

More Configurations:

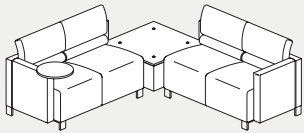

- Two 2-seat lounges without arms
- Tablet arm, wood
- Arm
- 90° in-line configurable table

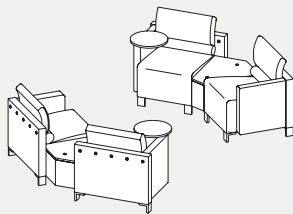

- Four 1-seat lounges without arms
- Two tablet arms, wood
- Two arms
- Two 45° in-line configurable tables

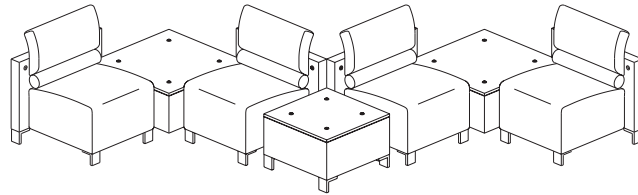

Description	Base Model*	Quantity	Price
1-seat lounge without arms	K90AA	4	\$ 1785 ea
24" square end table	K90BD	1	1199
90° In-Line configurable table	K90KP	2	<u>1356</u> ea
<i>Configuration dimensions: 170" x 77"</i>		Total	\$11051

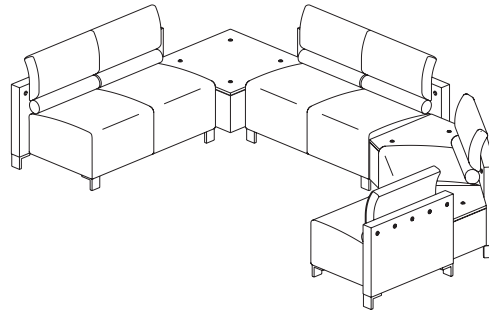

Description	Base Model*	Quantity	Price
2-seat lounge without arms	K90BB	2	\$ 2748 ea
1-seat lounge without arms	K90AA	2	1785 ea
45° in-line configurable table	K90MR	2	1356 ea
90° In-Line configurable table	K90KP	1	<u>1356</u>
<i>Configuration dimensions: 80" x 140"</i>		Total	\$13134

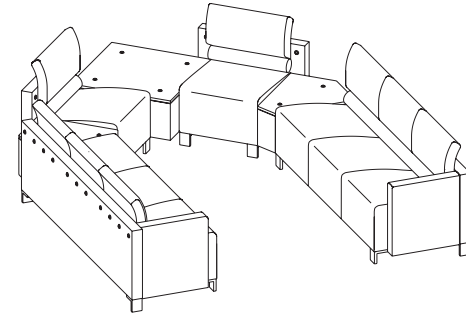

Description	Base Model*	Quantity	Price
3-seat lounge without arms	K90CC	2	\$ 3773 ea
Arm	K90ARM	2	301 ea
1-seat lounge without arms	K90AA	2	1785 ea
45° in-line configurable table	K90MR	2	1356 ea
90° in-line configurable table	K90KP	1	<u>1356</u>
<i>Configuration dimensions: 156" x 96"</i>		Total	\$15786

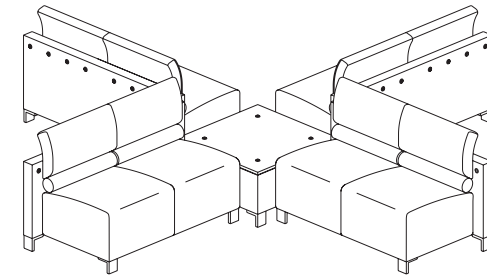

Description	Base Model*	Quantity	Price
2-seat lounge without arms	K90BB	4	\$ 2748 ea
30" square end table	K90CE	1	<u>1445</u>
<i>Configuration dimensions: 150" x 150"</i>		Total	\$12437

Delano

Actual Dimensions

Related Products:



Ottoman

Model	K90AC
Depth	24"
Width	24"
Height	18"

Storage Drawer on Tandem Seating & Configurable Tables

Outside Depth	18"
Outside Width	21½"
Outside Height	8½"
Inside Depth	17"
Inside Width	20½"
Inside Height	8¼"



1-Seat Lounge



2-Seat Lounge



3-Seat Lounge



2-Seat Bench

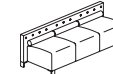

3-Seat Bench

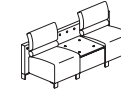

Tandem with Center Table



Tandem with End Table

Model	K90DD K90DDTL K90DDTR K90AA	K90EE K90BB	K90HH K90CC	K90JJ	K90KK	K90MM, K90RR, K90MML, K90RRTL, K90MMTR, K90RRTB, K90MMTB, K90RRTB K90PP, K90SS	K90YY, K90ZZ K90AB, K90BC K90TT, K90V K90WW, K90XX
Depth	27¾"	27¾"	27¾"	27¾"	27¾"	27¾"	27¾"
Width	32"	56"	80"	56"	80"	80"	80"
Height	33"	33"	33"	25"	25"	33"	33"
Arm Height (if applicable)	25"	25"	25"	—	—	25"	25"
Seat Depth	20"	20"	20"	20"	20"	20"	20"
Seat Width	24"	48"	72"	48"	72"	24" + 24"	48"
Seat Height	18"	18"	18"	18"	18"	18"	18"

► See pricing pages for table dimensions.

Lounge Seating

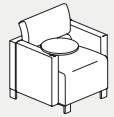
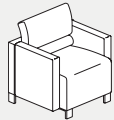

Kimball Office Upholstery Price Grade

Model	1 or COM	2	3 or COL	4	5	6	7	L7	L8
With Arms									
<i>3-Seat Lounge</i>									
K90HH	\$4255	\$4458	\$4584	\$4717	\$4899	\$5095	\$5291	\$6096	\$6551
<i>2-Seat Lounge</i>									
K90EE	\$3230	\$3393	\$3494	\$3599	\$3745	\$3902	\$4059	\$4703	\$5067
<i>1-Seat Lounge (shown)</i>									
K90DD	\$2266	\$2385	\$2460	\$2537	\$2644	\$2758	\$2872	\$3344	\$3610
<i>1-Seat Lounge With Tablet Arm, Left</i>									
K90DDTL	\$2628	\$2747	\$2822	\$2899	\$3006	\$3120	\$3234	\$3706	\$3972
<i>1-Seat Lounge With Tablet Arm, Right (shown)</i>									
K90DDTR	\$2628	\$2747	\$2822	\$2899	\$3006	\$3120	\$3234	\$3706	\$3972
Without Arms									
<i>3-Seat Lounge</i>									
K90CC	\$3773	\$3938	\$4041	\$4149	\$4297	\$4457	\$4617	\$5272	\$5643
<i>2-Seat Lounge</i>									
K90BB	\$2748	\$2873	\$2950	\$3031	\$3143	\$3264	\$3385	\$3879	\$4159
<i>1-Seat Lounge (shown)</i>									
K90AA	\$1785	\$1867	\$1918	\$1970	\$2043	\$2121	\$2199	\$2522	\$2703

Related Products:

- Arms and tablet arms for field installation
➤ See page 80.

Options:

Description	How to Specify	Add/Deduct \$
Contrasting upholstery ➤ See page 226.	Specify different fabrics or leathers for back, bolster, and seat/arms	Use electronic specification tool.

➤ See page

Finishes & Materials	211
COM/COL Yardage Req.	246
Alliance Program Pricing	83

Specifying Tips:

- When specifying a striped or directional upholstery, a solid pattern is recommended for the bolster.
- TB133 fire code treatment is available on select upholstery.
➤ See page 219 for upholstery.
➤ See page 257 for TB133 pricing.
➤ See page 267 for COM or COL.

How to Specify:

① Model

Back:

- ② Upholstery grade
- ③ Upholstery number

Accent/Bolster:

- ④ Upholstery grade
- ⑤ Upholstery number

Seat/Arms (primary):

- ⑥ Upholstery grade
- ⑦ Upholstery number

Wall and/or Tablet Surface:

- ⑧ Wood finish price group:
STD = Group 1
STD2 = Group 2 (+20%)
- ⑨ Wood finish designator
- ⑩ Tablet writing surface (include for tablet arm models only):
W = Wood
T = Black thermofoil (-\$50)
- ⑪ Fastener finish:
462 = Cinder

Bench and Ottoman

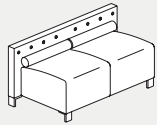

Model	Kimball Office Upholstery Price Grade								
	1 or COM	2	3 or COL	4	5	6	7	L7	L8
Bench									
<i>3-Seat Bench</i>									
K90KK	\$3411	\$3527	\$3599	\$3675	\$3779	\$3891	\$4003	\$4463	\$4723
<i>2-Seat Bench (shown)</i>									
K90JJ	\$2507	\$2591	\$2643	\$2698	\$2773	\$2855	\$2937	\$3270	\$3459
Ottoman									
K90AC	\$784	\$828	\$855	\$883	\$922	\$964	\$1006	\$1179	\$1276

Options:

Description	How to Specify	Add/Deduct \$
Contrasting upholstery ▶ See page 226.	Specify different fabrics or leathers for back, bolster, and seat/arms	Use electronic specification tool.

Kimball Office Seating

** Effective November 15, 2011 **

Page 75

▶ See page

Finishes & Materials	211
COM/COL Yardage Req.	246
Alliance Program Pricing	83

Specifying Tips:

- When specifying a striped or directional upholstery, a solid pattern is recommended for the bolster.
- TB133 fire code treatment is available on select upholstery.
 - ▶ See page 219 for upholstery.
 - ▶ See page 257 for TB133 pricing.
 - ▶ See page 267 for COM or COL.

How to Specify:

Bench

① Model

Accent/Bolster:

② Upholstery grade

③ Upholstery number

Seat (primary):

④ Upholstery grade

⑤ Upholstery number

Wall:

⑥ Wood finish price group:

STD = Group 1

STD2 = Group 2 (+20%)

⑦ Wood finish designator

⑧ Fastener finish:

462 = Cinder

Sample (base model underlined):

① ② ③ ④ ⑤

K90KK 2 20020 2 20020

⑥ ⑦ ⑧

STD MC 462

Ottoman

① Model

② Upholstery grade

③ Upholstery number

Delano

Tandem Seating Center In-Line Non-Storage Table

➤ See page

Finishes & Materials	211
COM/COL Yardage Req.	246
Alliance Program Pricing	83

Specifying Tips:

- When specifying a striped or directional upholstery, a solid pattern is recommended for the bolster.
- TB133 fire code treatment is available on select upholstery.
 - See page 219 for upholstery.
 - See page 257 for TB133 pricing.
 - See page 267 for COM or COL.

How to Specify:

- ① Model
- Back:**
 - ② Upholstery grade
 - ③ Upholstery number
- Accent/Bolster:**
 - ④ Upholstery grade
 - ⑤ Upholstery number
- Seat/Arms** (primary):
 - ⑥ Upholstery grade
 - ⑦ Upholstery number
- Wall and/or Tablet Surface:**
 - ⑧ Wood finish price group:
 - STD** = Group 1
 - STD2** = Group 2 (+20%)
 - ⑨ Wood finish designator
 - ⑩ Tablet writing surface (include for tablet arm models only):
 - W** = Wood
 - T** = Black thermofoil (-\$50)
 - ⑪ Fastener finish:
 - 462** = Cinder

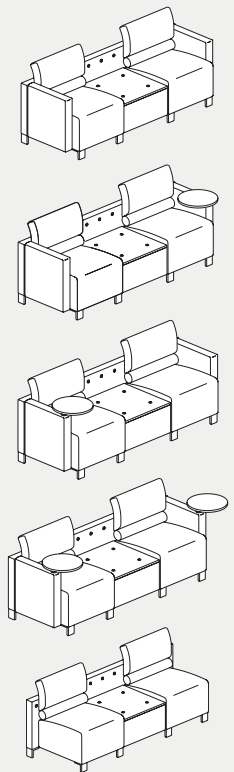

Kimball Office Upholstery Price Grade

Model	1 or COM	2	3 or COL	4	5	6	7	L7	L8
With Arms									
<i>Without Tablet Arm</i>									
K90MM	\$4736	\$4919	\$5032	\$5151	\$5315	\$5492	\$5669	\$6393	\$6803
<i>With Tablet Arm, Left</i>									
K90MML	\$5099	\$5282	\$5395	\$5514	\$5678	\$5855	\$6032	\$6756	\$7166
<i>With Tablet Arm, Right</i>									
K90MMR	\$5099	\$5282	\$5395	\$5514	\$5678	\$5855	\$6032	\$6756	\$7166
<i>With Tablet Arms, Left and Right</i>									
K90MMTB	\$5460	\$5643	\$5756	\$5875	\$6039	\$6216	\$6393	\$7117	\$7527
Without Arms									
K90PP	\$4255	\$4400	\$4490	\$4584	\$4715	\$4855	\$4995	\$5570	\$5895

Options:

Description	How to Specify	Add/Deduct \$
Contrasting upholstery ➤ See page 226.	Specify different fabrics or leathers for back, bolster, and seat/arms	Use electronic specification tool.

Related Products:

- Arms and tablet arms for field installation
➤ See page 80.

Delano

Tandem Seating Center In-Line Storage Table

▶ See page

Finishes & Materials	211
COM/COL Yardage Req.	246
Alliance Program Pricing	83

Specifying Tips:

- When specifying a striped or directional upholstery, a solid pattern is recommended for the bolster.
- TB133 fire code treatment is available on select upholstery.
 - ▶ See page 219 for upholstery.
 - ▶ See page 257 for TB133 pricing.
 - ▶ See page 267 for COM or COL.

How to Specify:

① Model

Back:

- ② Upholstery grade
- ③ Upholstery number

Accent/Bolster:

- ④ Upholstery grade
- ⑤ Upholstery number

Seat/Arms (primary):

- ⑥ Upholstery grade
- ⑦ Upholstery number

Wall and/or Tablet Surface:

- ⑧ Wood finish price group:
 - STD** = Group 1
 - STD2** = Group 2 (+20%)
- ⑨ Wood finish designator
- ⑩ Tablet writing surface (include for tablet arm models only):
 - W** = Wood
 - T** = Black thermofoil (-\$50)
- ⑪ Fastener finish:
 - 462** = Cinder

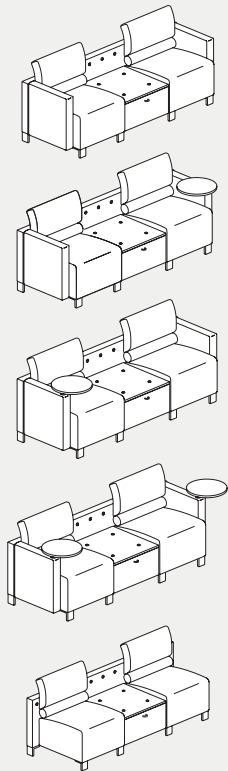

Kimball Office Upholstery Price Grade

Model	1 or COM	2	3 or COL	4	5	6	7	L7	L8
With Arms									
<i>Without Tablet Arm</i>									
K90RR	\$5038	\$5221	\$5334	\$5453	\$5617	\$5794	\$5971	\$6695	\$7105
<i>With Tablet Arm, Left</i>									
K90RRTL	\$5400	\$5583	\$5696	\$5815	\$5979	\$6156	\$6333	\$7057	\$7467
<i>With Tablet Arm, Right</i>									
K90RRTR	\$5400	\$5583	\$5696	\$5815	\$5979	\$6156	\$6333	\$7057	\$7467
<i>With Tablet Arms, Left and Right</i>									
K90RTTB	\$5762	\$5945	\$6058	\$6177	\$6341	\$6518	\$6695	\$7419	\$7829
Without Arms									
K90SS	\$4556	\$4704	\$4796	\$4892	\$5025	\$5168	\$5311	\$5897	\$6229

Options:

Description	How to Specify	Add/Deduct \$
Contrasting upholstery ▶ See page 226.	Specify different fabrics or leathers for back, bolster, and seat/arms	Use electronic specification tool.

Related Products:

- Arms and tablet arms for field installation
▶ See page 80.

Delano

Tandem Seating End In-Line Non-Storage Table

➤ See page

Finishes & Materials	211
COM/COL Yardage Req.	246
Alliance Program Pricing	83

Kimball Office Upholstery Price Grade

Model	1 or COM	2	3 or COL	4	5	6	7	L7	L8
-------	----------	---	----------	---	---	---	---	----	----

With Arm

Table, Left (as seated) and Arm, Right

K90YY	\$4556	\$4701	\$4791	\$4885	\$5016	\$5156	\$5296	\$5871	\$6196
--------------	--------	--------	--------	--------	--------	--------	--------	--------	--------

Table, Right (as seated) and Arm Left

K90TT	\$4556	\$4719	\$4820	\$4925	\$5071	\$5228	\$5385	\$6029	\$6393
--------------	--------	--------	--------	--------	--------	--------	--------	--------	--------

Without Arm

Table, Left (as seated)

K90AB	\$4314	\$4439	\$4516	\$4597	\$4709	\$4830	\$4951	\$5445	\$5725
--------------	--------	--------	--------	--------	--------	--------	--------	--------	--------

Table, Right (as seated)

K90WW	\$4314	\$4439	\$4516	\$4597	\$4709	\$4830	\$4951	\$5445	\$5725
--------------	--------	--------	--------	--------	--------	--------	--------	--------	--------

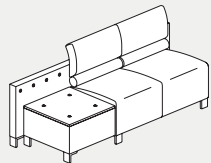
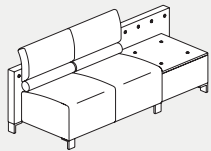
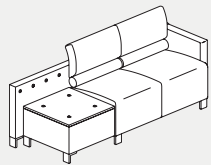
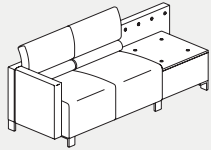

Specifying Tips:

- When specifying a striped or directional upholstery, a solid pattern is recommended for the bolster.
- TB133 fire code treatment is available on select upholstery.
 - See page 219 for upholstery.
 - See page 257 for TB133 pricing.
 - See page 267 for COM or COL.

How to Specify:

- ① Model
 - ② Upholstery grade
 - ③ Upholstery number
- Accent/Bolster:**
- ④ Upholstery grade
 - ⑤ Upholstery number
- Seat/Arms** (primary):
- ⑥ Upholstery grade
 - ⑦ Upholstery number
- Wall:**
- ⑧ Wood finish price group:
 - STD** = Group 1
 - STD2** = Group 2 (+20%)
 - ⑨ Wood finish designator
 - ⑩ Fastener finish:
 - 462** = Cinder

Related Products:

- Arms and tablet arms for field installation
 - See page 80.

Options:

Description	How to Specify	Add/Deduct \$
Contrasting upholstery ➤ See page 226.	Specify different fabrics or leathers for back, bolster, and seat/arms	Use electronic specification tool.

Tandem Seating End In-Line Storage Table

➤ See page

Finishes & Materials	211
COM/COL Yardage Req.	246
Alliance Program Pricing	83

Kimball Office Upholstery Price Grade

Model	1 or COM	2	3 or COL	4	5	6	7	L7	L8
-------	----------	---	----------	---	---	---	---	----	----

With Arm

Storage Table, Left (as seated) and Arm, Right

K90ZZ	\$4858	\$5003	\$5093	\$5187	\$5318	\$5458	\$5598	\$6173	\$6498
--------------	--------	--------	--------	--------	--------	--------	--------	--------	--------

Storage Table, Right (as seated) and Arm Left

K90VV	\$4858	\$5021	\$5122	\$5227	\$5373	\$5530	\$5687	\$6331	\$6695
--------------	--------	--------	--------	--------	--------	--------	--------	--------	--------

Without Arm

Storage Table, Left (as seated)

K90BC	\$4617	\$4742	\$4819	\$4900	\$5012	\$5133	\$5254	\$5748	\$6028
--------------	--------	--------	--------	--------	--------	--------	--------	--------	--------

Storage Table, Right (as seated)

K90XX	\$4617	\$4742	\$4819	\$4900	\$5012	\$5133	\$5254	\$5748	\$6028
--------------	--------	--------	--------	--------	--------	--------	--------	--------	--------

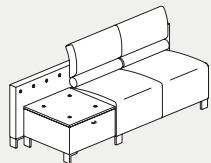
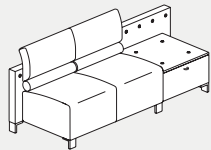
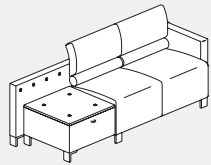
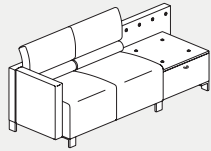

Specifying Tips:

- When specifying a striped or directional upholstery, a solid pattern is recommended for the bolster.
- TB133 fire code treatment is available on select upholstery.
 - See page 219 for upholstery.
 - See page 257 for TB133 pricing.
 - See page 267 for COM or COL.

How to Specify:

- Model
- Back:**
- Upholstery grade
- Upholstery number
- Accent/Bolster:**
- Upholstery grade
- Upholstery number
- Seat/Arms** (primary):
- Upholstery grade
- Upholstery number
- Wall:**
- Wood finish price group:
 - STD** = Group 1
 - STD2** = Group 2 (+20%)
- Wood finish designator
- Fastener finish:
 - 462** = Cinder

Related Products:

- Arms and tablet arms for field installation
 - See page 80.

Options:

Description	How to Specify	Add/Deduct \$
Contrasting upholstery ➤ See page 226.	Specify different fabrics or leathers for back, bolster, and seat/arms	Use electronic specification tool.



Arms and Tablet Arms For Field Installation on Lounge or Tandem Seating

Kimball Office Upholstery Price Grade

Model	1 or COM	2	3 or COL	4	5	6	7	L7	L8
Non-Handed Arm									
K90ARM	\$301	\$342	\$367	\$393	\$430	\$469	\$508	\$669	\$760
Non-Handed Tablet Arm									
<i>With Wood Writing Surface</i>									
K90TBLARMW	\$724	\$765	\$790	\$816	\$853	\$892	\$931	\$1092	\$1183
<i>With Black Thermofoil Writing Surface</i>									
K90TBLARMT	\$636	\$677	\$702	\$728	\$765	\$804	\$843	\$1004	\$1095

Standard:

- Two flat attachment brackets
- Eight screws

▶ See page

Finishes & Materials	211
COM/COL Yardage Req.	246
Alliance Program Pricing	83

Specifying Tips:

- TB133 fire code treatment is available on select upholstery.
 - ▶ See page 219 for upholstery.
 - ▶ See page 257 for TB133 pricing.
 - ▶ See page 267 for COM or COL.

How to Specify:

Arm or Tablet Arm with Thermofoil Writing Surface

- ① Model
- ② Upholstery grade
- ③ Upholstery number
- ④ Fastener finish:

462 = Cinder

Sample (base model underlined):

① ② ③ ④
K90ARM 2 20020 462

Tablet Arm with Wood Writing Surface

- ① Model
- ② Upholstery grade
- ③ Upholstery number
- ④ Wood finish price group:

STD = Group 1

STD2 = Group 2 (+20%)

- ⑤ Wood finish designator
- ⑥ Fastener finish:

462 = Cinder

Sample (base model underlined):

① ② ③ ④
K90TBLARMW 2 20020 STD
 ⑤ ⑥
 MC 462

Freestanding Tables

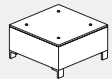
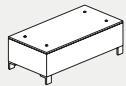

<i>D</i>	<i>W</i>	<i>H</i>	<i>Model</i>	<i>Price</i>
Rectangular Magazine Tables				
24"	36"	16"	K90DH	\$1601
24"	48"	16"	K90EJ	1948
Square End Tables				
24"	24"	16"	K90BD	\$1199
30"	30"	16"	K90CE	1445

How to Specify:

- ① Model
- ② Wood finish price group:
STD = Group 1
STD2 = Group 2 (+20%)
- ③ Wood finish designator
- ④ Fastener finish:
462 = Cinder

Sample (base model underlined):

① ② ③ ④
K90DH STD MC 462

Configurable Tables

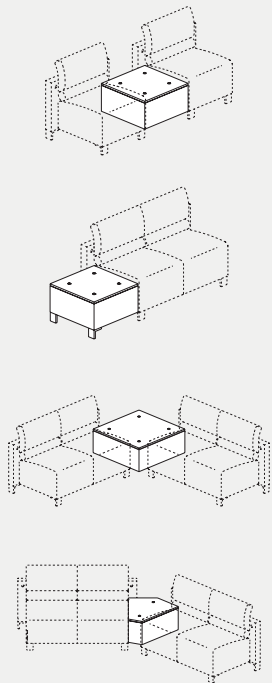

<i>D</i>	<i>W</i>	<i>H</i>	<i>Model</i>	<i>Description</i>	<i>Price</i>
Center In-Line Tables					
24"	24"	16"	K90HK	Table	\$1055
24"	24"	16"	K90PS	Storage table	1356
End In-Line Tables					
24"	24"	16"	K90JM	Table, for right or left	\$1115
24"	24"	16"	K90SV	Storage table, left	1416
24"	24"	16"	K90RT	Storage table, right	1416
90° In-Line Table					
30"	30"	16"	K90KP	90°	\$1356
45° In-Line Table					
27½"	25½"	16"	K90MR	45°	\$1356

Standard:

- Pull-out drawer on storage tables
 ▶ See page 73 for actual dimensions.
- Crescent pull on storage table: matte nickel-plated finish
- Attachment brackets

How to Specify:

- ① Model
- ② Wood finish price group:
STD = Group 1
STD2 = Group 2 (+20%)
- ③ Wood finish designator
- ④ Fastener finish:
462 = Cinder

Sample (base model underlined):

① ② ③ ④
K90HK STD MC 462

Delano

with Alliance Program Upholstery

IMPORTANT: Orders cannot be cancelled for chairs specified with Alliance Program upholstery.

Alliance Upholstery Price Grade

Model	A	B	C	D	E	F	G	H	I	
	J	K	L	M	N	O	P	Q	R	
Lounge Seating with Arms										
K90DD	\$2446	\$2524	\$2594	\$2656	\$2733	\$2815	\$2870	\$2954	\$3036	
	3111	3239	3496	3660	3681	3722	3763	3804	3977	
K90DDTL	2808	2886	2956	3018	3095	3177	3232	3316	3398	
	3473	3601	3858	4022	4043	4084	4125	4166	4339	
K90DDTR	2808	2886	2956	3018	3095	3177	3232	3316	3398	
	3473	3601	3858	4022	4043	4084	4125	4166	4339	
K90EE	3477	3583	3678	3763	3869	3981	4054	4171	4283	
	4383	4558	4910	5134	5163	5219	5275	5331	5566	
K90HH	4563	4696	4815	4921	5053	5193	5284	5431	5571	
	5697	5914	6355	6635	6671	6741	6811	6881	7174	

Specifying Tips:

- When specifying a striped or directional upholstery, a solid pattern is recommended for the bolster.
- TB133 fire code treatment is available on select upholstery. [▶ See page 267](#) for program overview.

Options:

Description	How to Specify	Add/Deduct \$
Contrasting upholstery ▶ See page 226.	Specify different fabrics or leathers for back, bolster, and seat/arms	Use electronic specification tool.

Kimball Office Seating

** Effective November 15, 2011 **

Delano

How to Specify:

- Model
- Back:** Alliance partner designator and upholstery grade:
CAR[grade] = Carnegie
KNL[grade] = KnollTextiles
MHM[grade] = Maharam
MAF[grade] = Mayer Fabrics
- Upholstery number
- Accent/Bolster:** Alliance partner designator and upholstery grade (see above)
- Upholstery number
- Seat/Arms** (primary): Alliance partner designator and upholstery grade (see above)
- Upholstery number
- Wall and/or Tablet Surface:** Wood finish price group:
STD = Group 1
STD2 = Group 2 (+20%)
- Wood finish designator
- Tablet writing surface (include for tablet arm models only):
W = Wood
T = Black thermofoil (-\$50)
- Fastener finish:
462 = Cinder

Sample (base model underlined):

① ② ③
K90DDTL CARJ 6136_10
 ④ ⑤ ⑥
 CARJ 6136_10 CARJ
 ⑦ ⑧ ⑨ ⑩ ⑪
 6136_10 STD MC W 462

Delano

with Alliance Program Upholstery, continued

IMPORTANT: Orders cannot be cancelled for chairs specified with Alliance Program upholstery.

Alliance Upholstery Price Grade

Model	A	B	C	D	E	F	G	H	I	
	J	K	L	M	N	O	P	Q	R	
Lounge Seating without Arms										
K90AA	\$1908	\$1962	\$2009	\$2052	\$2104	\$2160	\$2198	\$2255	\$2311	
	2362	2450	2625	2737	2752	2780	2808	2836	2954	
K90BB	2938	3019	3092	3157	3239	3325	3380	3471	3557	
	3633	3767	4038	4210	4232	4275	4318	4361	4541	
K90CC	4024	4132	4229	4315	4423	4537	4611	4731	4845	
	4947	5124	5483	5711	5740	5797	5854	5911	6150	
Benches										
K90JJ	2635	2690	2739	2783	2838	2896	2933	2995	3053	
	3104	3194	3377	3493	3508	3537	3566	3595	3716	
K90KK	3587	3663	3731	3791	3867	3947	3999	4083	4163	
	4235	4359	4611	4771	4791	4831	4871	4911	5079	

Specifying Tips:

- When specifying a striped or directional upholstery, a solid pattern is recommended for the bolster.
- TB133 fire code treatment is available on select upholstery. [▶ See page 267](#) for program overview.

Options:

Description	How to Specify	Add/Deduct \$
Contrasting upholstery ▶ See page 226.	Specify different fabrics or leathers for back, bolster, and seat/arms	Use electronic specification tool.

How to Specify:

- Model
- Alliance partner designator and upholstery grade:
CAR[grade] = Carnegie
KNL[grade] = KnollTextiles
MHM[grade] = Maharam
MAF[grade] = Mayer Fabrics
- Upholstery number
- Accent/Bolster:**
- Alliance partner designator and upholstery grade (see above)
- Upholstery number
- Seat** (primary):
- Alliance partner designator and upholstery grade (see above)
- Upholstery number
- Wall:**
- Wood finish price group:
STD = Group 1
STD2 = Group 2 (+20%)
- Wood finish designator
- Fastener finish:
462 = Cinder

Sample (base model underlined):

^① K90AA ^② CARJ ^③ 6136_10
^④ CARJ ^⑤ 6136_10 ^⑥ CARJ
^⑦ 6136_10 ^⑧ STD ^⑨ MC ^⑩ 462

Delano

with Alliance Program Upholstery, continued

IMPORTANT: Orders cannot be cancelled for chairs specified with Alliance Program upholstery.

Specifying Tips:

- When specifying a striped or directional upholstery, a solid pattern is recommended for the bolster.
- TB133 fire code treatment is available on select upholstery.
▶ See page 267 for program overview.

Model	Alliance Upholstery Price Grade									
	A	B	C	D	E	F	G	H	I	
	J	K	L	M	N	O	P	Q	R	
Tandem Seating with Arms and Center In-Line Table										
K90MM	\$5014	\$5133	\$5240	\$5335	\$5455	\$5581	\$5662	\$5795	\$5921	
	6033	6229	6626	6878	6910	6973	7036	7099	7363	
K90MMTB	5738	5857	5964	6059	6179	6305	6386	6519	6645	
	6757	6953	7350	7602	7634	7697	7760	7823	8087	
K90MRTL	5377	5496	5603	5698	5818	5944	6025	6158	6284	
	6396	6592	6989	7241	7273	7336	7399	7462	7726	
K90MMTR	5377	5496	5603	5698	5818	5944	6025	6158	6284	
	6396	6592	6989	7241	7273	7336	7399	7462	7726	
K90RR	5316	5435	5542	5637	5757	5883	5964	6097	6223	
	6335	6531	6928	7180	7212	7275	7338	7401	7665	
K90RRTB	6040	6159	6266	6361	6481	6607	6688	6821	6947	
	7059	7255	7652	7904	7936	7999	8062	8125	8389	
K90RRTL	5678	5797	5904	5999	6119	6245	6326	6459	6585	
	6697	6893	7290	7542	7574	7637	7700	7763	8027	
K90RRTR	5678	5797	5904	5999	6119	6245	6326	6459	6585	
	6697	6893	7290	7542	7574	7637	7700	7763	8027	

Options:

Description	How to Specify	Add/Deduct \$
Contrasting upholstery ▶ See page 226.	Specify different fabrics or leathers for back, bolster, and seat/arms	Use electronic specification tool.

Kimball Office Seating

** Effective November 15, 2011 **

Page 85

Delano

How to Specify:

- ① Model
- ② Alliance partner designator and upholstery grade:
CAR[grade] = Carnegie
KNL[grade] = KnollTextiles
MHM[grade] = Maharam
MAF[grade] = Mayer Fabrics
- ③ Upholstery number
- ④ Alliance partner designator and upholstery grade (see above)
- ⑤ Upholstery number
- ⑥ Alliance partner designator and upholstery grade (see above)
- ⑦ Upholstery number
- ⑧ Wood finish price group:
STD = Group 1
STD2 = Group 2 (+20%)
- ⑨ Wood finish designator
- ⑩ Tablet writing surface (include for tablet arm models only):
W = Wood
T = Black thermofoil (-\$50)
- ⑪ Fastener finish:
462 = Cinder

Sample (base model underlined):

① ② ③
K90MRTL CARJ 6136_10
 ④ ⑤ ⑥
 CARJ 6136_10 CARJ
 ⑦ ⑧ ⑨ ⑩ ⑪
 6136_10 STD MC W 462

Delano

with Alliance Program Upholstery, continued

IMPORTANT: Orders cannot be cancelled for chairs specified with Alliance Program upholstery.

Specifying Tips:

- When specifying a striped or directional upholstery, a solid pattern is recommended for the bolster.
- TB133 fire code treatment is available on select upholstery. [▶See page 267](#) for program overview.

Model	Alliance Upholstery Price Grade								
	A	B	C	D	E	F	G	H	I
	J	K	L	M	N	O	P	Q	R
Tandem Seating with Arms and End In-Line Table									
K90TT	4803	4909	5004	5089	5195	5307	5380	5497	5609
	5709	5884	6236	6460	6489	6545	6601	6657	6892
K90VV	5105	5211	5306	5391	5497	5609	5682	5799	5911
	6011	6186	6538	6762	6791	6847	6903	6959	7194
K90YY	4777	4871	4956	5032	5127	5227	5291	5396	5496
	5585	5741	6056	6256	6282	6332	6382	6432	6641
K90ZZ	5079	5173	5258	5334	5429	5529	5593	5698	5798
	5887	6043	6358	6558	6584	6634	6684	6734	6943

Options:

Description	How to Specify	Add/Deduct \$
Contrasting upholstery ▶See page 226.	Specify different fabrics or leathers for back, bolster, and seat/arms	Use electronic specification tool.

How to Specify:

- ① Model
- ② Alliance partner designator and upholstery grade:
CAR[grade] = Carnegie
KNL[grade] = KnollTextiles
MHM[grade] = Maharam
MAF[grade] = Mayer Fabrics
- ③ Upholstery number
- ④ Alliance partner designator and upholstery grade (see above)
- ⑤ Upholstery number
- ⑥ Alliance partner designator and upholstery grade (see above)
- ⑦ Upholstery number
- ⑧ Wood finish price group:
STD = Group 1
STD2 = Group 2 (+20%)
- ⑨ Wood finish designator
- ⑩ Fastener finish:
462 = Cinder

Sample (base model underlined):

① ② ③
K90TT CARJ 6136_10
 ④ ⑤ ⑥
 CARJ 6136_10 CARJ
 ⑦ ⑧ ⑨ ⑩
 6136_10 STD MC 462

Delano

with Alliance Program Upholstery, continued

IMPORTANT: Orders cannot be cancelled for chairs specified with Alliance Program upholstery.

Specifying Tips:

- When specifying a striped or directional upholstery, a solid pattern is recommended for the bolster.
- TB133 fire code treatment is available on select upholstery. [▶ See page 267](#) for program overview.

Model	Alliance Upholstery Price Grade									
	A	B	C	D	E	F	G	H	I	
	J	K	L	M	N	O	P	Q	R	
Tandem Seating without Arms										
K90AB	\$4504	\$4585	\$4658	\$4723	\$4805	\$4891	\$4946	\$5037	\$5123	
	5199	5333	5604	5776	5798	5841	5884	5927	6107	
K90BC	4807	4888	4961	5026	5108	5194	5249	5340	5426	
	5502	5636	5907	6079	6101	6144	6187	6230	6410	
K90PP	4476	4570	4655	4731	4826	4926	4990	5095	5195	
	5284	5440	5755	5955	5981	6031	6081	6131	6340	
K90SS	4781	4877	4964	5041	5138	5240	5306	5413	5515	
	5606	5765	6086	6290	6316	6367	6418	6469	6683	
K90WW	4504	4585	4658	4723	4805	4891	4946	5037	5123	
	5199	5333	5604	5776	5798	5841	5884	5927	6107	
K90XX	4807	4888	4961	5026	5108	5194	5249	5340	5426	
	5502	5636	5907	6079	6101	6144	6187	6230	6410	

Options:

Description	How to Specify	Add/Deduct \$
Contrasting upholstery ▶ See page 226.	Specify different fabrics or leathers for back, bolster, and seat/arms	Use electronic specification tool.

How to Specify:

- ① Model
- ② Alliance partner designator and upholstery grade:
CAR[grade] = Carnegie
KNL[grade] = KnollTextiles
MHM[grade] = Maharam
MAF[grade] = Mayer Fabrics
- ③ Upholstery number
- ④ Alliance partner designator and upholstery grade (see above)
- ⑤ Upholstery number
- ⑥ Alliance partner designator and upholstery grade (see above)
- ⑦ Upholstery number
- ⑧ Wood finish price group:
STD = Group 1
STD2 = Group 2 (+20%)
- ⑨ Wood finish designator
- ⑩ Fastener finish:
462 = Cinder

Sample (base model underlined):

① ② ③
K90AB CARJ 6136_10
 ④ ⑤ ⑥
 CARJ 6136_10 CARJ
 ⑦ ⑧ ⑨ ⑩
 6136_10 STD MC 462

Delano

with Alliance Program Upholstery, continued

IMPORTANT: Orders cannot be cancelled for chairs specified with Alliance Program upholstery.

Alliance Upholstery Price Grade

Model	A	B	C	D	E	F	G	H	I
	J	K	L	M	N	O	P	Q	R
Ottoman									
K90AC	\$850	\$879	\$904	\$927	\$955	\$985	\$1005	\$1036	\$1066
	1093	1140	1234	1294	1302	1317	1332	1347	1410
Arm									
K90ARM	363	389	413	434	461	489	507	536	564
	589	633	721	777	784	798	812	826	885
Tablet Arms									
<i>With Black Thermofoil Writing Surface</i>									
K90TBLTARMT	698	724	748	769	796	824	842	871	899
	924	968	1056	1112	1119	1133	1147	1161	1220
<i>With Wood Writing Surface</i>									
K90TBLTARMW	786	812	836	857	884	912	930	959	987
	1012	1056	1144	1200	1207	1221	1235	1249	1308

Specifying Tips:

- TB133 fire code treatment is available on select upholstery.
- ▶ See page 267 for program overview.

How to Specify:

Ottoman

- ① Model
- ② Alliance partner designator and upholstery grade:
CAR[grade] = Carnegie
KNL[grade] = KnollTextiles
MHM[grade] = Maharam
MAF[grade] = Mayer Fabrics
- ③ Upholstery number

Sample (base model underlined):

① ② ③

K90AC CARJ 6136_10

Arm

- ① Model
- ② Alliance partner designator and upholstery grade (see above)
- ③ Upholstery number
- ④ Fastener finish:
462 = Cinder

Tablet Arm

- ① Model
- ② Alliance partner designator and upholstery grade (see above)
- ③ Upholstery number
- ④ Wood finish price group (omit for thermofoil model):
STD = Group 1
STD2 = Group 2 (+20%)
- ⑤ Wood finish designator (omit for thermofoil model)
- ⑥ Fastener finish:
462 = Cinder