

## Statement of Line

▶ See page

Finishes & Materials	325
Overview	288

### At a Glance:



#### High-Back Desk Chairs

▶ See below for Statement of Line.



#### Mid-Back Desk Chairs

▶ See page 286 for Statement of Line.



#### Stacking Side Chairs

▶ See page 287 for Statement of Line.

*Hero. Just for You.*  
*Hero's agile, slim-line*  
*form and auto-fit*  
*synchronous mechanism*  
*automatically aligns to*  
*each user, giving*  
*ergonomically correct,*  
*flexible support, for use*  
*throughout the*  
*organization. Available*  
*fully upholstered or*  
*with innovative ribbed*  
*mesh backrest*

### High-Back Desk Chairs:



#### Mesh Back with Arms

▶ See page 289 to specify.

Height	47 <sup>3</sup> / <sub>4</sub> "–57 <sup>1</sup> / <sub>4</sub> "*
Width	29 <sup>3</sup> / <sub>8</sub> "
Depth	28 <sup>3</sup> / <sub>8</sub> "
Arm height	24 <sup>1</sup> / <sub>8</sub> "–34 <sup>3</sup> / <sub>8</sub> "*
Seat height	16 <sup>1</sup> / <sub>4</sub> "–22 <sup>7</sup> / <sub>16</sub> "*
Seat width	18 <sup>1</sup> / <sub>2</sub> "
Seat depth	16 <sup>3</sup> / <sub>4</sub> "–18 <sup>3</sup> / <sub>4</sub> "
Kneespace	22 <sup>7</sup> / <sub>8</sub> "



#### Mesh Back without Arms

▶ See page 289 to specify.

Height	47 <sup>3</sup> / <sub>4</sub> "–57 <sup>1</sup> / <sub>4</sub> "*
Width	29 <sup>3</sup> / <sub>8</sub> "
Depth	28 <sup>3</sup> / <sub>8</sub> "
Arm height	—
Seat height	16 <sup>1</sup> / <sub>4</sub> "–22 <sup>7</sup> / <sub>16</sub> "*
Seat width	18 <sup>1</sup> / <sub>2</sub> "
Seat depth	16 <sup>3</sup> / <sub>4</sub> "–18 <sup>3</sup> / <sub>4</sub> "
Kneespace	22 <sup>7</sup> / <sub>8</sub> "



#### Upholstered Back with Arms

▶ See page 290 to specify.

Height	47 <sup>3</sup> / <sub>4</sub> "–57 <sup>1</sup> / <sub>4</sub> "*
Width	29 <sup>3</sup> / <sub>8</sub> "
Depth	28 <sup>3</sup> / <sub>8</sub> "
Arm height	24 <sup>1</sup> / <sub>8</sub> "–34 <sup>3</sup> / <sub>8</sub> "*
Seat height	16 <sup>1</sup> / <sub>4</sub> "–22 <sup>7</sup> / <sub>16</sub> "*
Seat width	18 <sup>1</sup> / <sub>2</sub> "
Seat depth	16 <sup>3</sup> / <sub>8</sub> "–18 <sup>3</sup> / <sub>8</sub> "
Kneespace	22 <sup>7</sup> / <sub>8</sub> "



#### Upholstered Back without Arms

▶ See page 290 to specify.

Height	47 <sup>3</sup> / <sub>4</sub> "–57 <sup>1</sup> / <sub>4</sub> "*
Width	29 <sup>3</sup> / <sub>8</sub> "
Depth	28 <sup>3</sup> / <sub>8</sub> "
Arm height	—
Seat height	16 <sup>1</sup> / <sub>4</sub> "–22 <sup>7</sup> / <sub>16</sub> "*
Seat width	18 <sup>1</sup> / <sub>2</sub> "
Seat depth	16 <sup>3</sup> / <sub>8</sub> "–18 <sup>3</sup> / <sub>8</sub> "*
Kneespace	22 <sup>7</sup> / <sub>8</sub> "

*Note: Measurements were obtained using the ANSI/BIFMA accepted chair measurement device and process.*

\* Patented twist/threaded column allows pneumatic cylinder to be adjusted, resulting in varying ranges for overall, seat, and arm heights.

▶ See page 286 for ranges based on position of the twist/threaded column.

Hero.  
Just for You.

## Statement of Line, continued

► See page

Finishes & Materials	325
Overview	288

### Height Ranges:

**Patented twist/threaded column** allows pneumatic cylinder to be adjusted, resulting in varying ranges for overall, seat, and arm heights.

#### High Back Desk Chairs

##### Lowest Column Position

Overall height	47 <sup>3</sup> / <sub>4</sub> "–55 <sup>1</sup> / <sub>4</sub> "
Arm height	24 <sup>1</sup> / <sub>8</sub> "–32 <sup>5</sup> / <sub>8</sub> "
Seat height	16 <sup>1</sup> / <sub>4</sub> "–20 <sup>3</sup> / <sub>4</sub> "

##### Highest Column Position

Overall height	49 <sup>13</sup> / <sub>16</sub> "–57 <sup>1</sup> / <sub>4</sub> "
Arm height	25 <sup>3</sup> / <sub>4</sub> "–34 <sup>3</sup> / <sub>8</sub> "
Seat height	18 <sup>3</sup> / <sub>16</sub> "–22 <sup>7</sup> / <sub>16</sub> "

#### Mid-Back Desk Chairs

##### Lowest Column Position

Overall height	41"–45 <sup>1</sup> / <sub>4</sub> "
Arm height	24 <sup>1</sup> / <sub>8</sub> "–32 <sup>5</sup> / <sub>8</sub> "
Seat height	16 <sup>1</sup> / <sub>4</sub> "–20 <sup>3</sup> / <sub>4</sub> "

##### Highest Column Position

Overall height	42 <sup>9</sup> / <sub>16</sub> "–47 <sup>1</sup> / <sub>4</sub> "
Arm height	25 <sup>3</sup> / <sub>4</sub> "–34 <sup>3</sup> / <sub>8</sub> "
Seat height	18 <sup>3</sup> / <sub>16</sub> "–22 <sup>7</sup> / <sub>16</sub> "

*Note: Chairs are shipped with the column set at a mid-point between the lowest and highest positions.*

### Mid-Back Desk Chairs:



#### Mesh Back with Arms

► See page 289 to specify.

Height	41"–47 <sup>1</sup> / <sub>4</sub> "*
Width	29 <sup>3</sup> / <sub>8</sub> "
Depth	28 <sup>3</sup> / <sub>8</sub> "
Arm height	24 <sup>1</sup> / <sub>8</sub> "–34 <sup>3</sup> / <sub>8</sub> "*
Seat height	16 <sup>1</sup> / <sub>4</sub> "–22 <sup>7</sup> / <sub>16</sub> "*
Seat width	18 <sup>1</sup> / <sub>2</sub> "
Seat depth	16 <sup>3</sup> / <sub>4</sub> "–18 <sup>3</sup> / <sub>4</sub> "
Kneespace	22 <sup>7</sup> / <sub>8</sub> "



#### Mesh Back without Arms

► See page 289 to specify.

Height	41"–47 <sup>1</sup> / <sub>4</sub> "*
Width	29 <sup>3</sup> / <sub>8</sub> "
Depth	28 <sup>3</sup> / <sub>8</sub> "
Arm height	—
Seat height	16 <sup>1</sup> / <sub>4</sub> "–22 <sup>7</sup> / <sub>16</sub> "*
Seat width	18 <sup>1</sup> / <sub>2</sub> "
Seat depth	16 <sup>3</sup> / <sub>4</sub> "–18 <sup>3</sup> / <sub>4</sub> "
Kneespace	22 <sup>7</sup> / <sub>8</sub> "



#### Upholstered Back with Arms

► See page 290 to specify.

Height	41"–47 <sup>1</sup> / <sub>4</sub> "*
Width	29 <sup>3</sup> / <sub>8</sub> "
Depth	28 <sup>3</sup> / <sub>8</sub> "
Arm height	24 <sup>1</sup> / <sub>8</sub> "–34 <sup>3</sup> / <sub>8</sub> "*
Seat height	16 <sup>1</sup> / <sub>4</sub> "–22 <sup>7</sup> / <sub>16</sub> "*
Seat width	18 <sup>1</sup> / <sub>2</sub> "
Seat depth	16 <sup>3</sup> / <sub>8</sub> "–18 <sup>3</sup> / <sub>8</sub> "
Kneespace	22 <sup>7</sup> / <sub>8</sub> "



#### Upholstered Back without Arms

► See page 290 to specify.

Height	41"–47 <sup>1</sup> / <sub>4</sub> "*
Width	29 <sup>3</sup> / <sub>8</sub> "
Depth	28 <sup>3</sup> / <sub>8</sub> "
Arm height	—
Seat height	16 <sup>1</sup> / <sub>4</sub> "–22 <sup>7</sup> / <sub>16</sub> "*
Seat width	18 <sup>1</sup> / <sub>2</sub> "
Seat depth	16 <sup>3</sup> / <sub>8</sub> "–18 <sup>3</sup> / <sub>8</sub> "
Kneespace	22 <sup>7</sup> / <sub>8</sub> "

*Note: Measurements were obtained using the ANSI/BIFMA accepted chair measurement device and process.*

\* Patented twist/threaded column allows pneumatic cylinder to be adjusted, resulting in varying ranges for overall, seat, and arm heights.

► See table at left for ranges based on position of the twist/threaded column.

*Note: Measurements were obtained using the ANSI/BIFMA accepted chair measurement device and process.*

Stacking Side Chairs:



**Mesh Back**

► See page 291 to specify.

Height	36 <sup>1</sup> / <sub>4</sub> "
Width	24"
Depth	24 <sup>5</sup> / <sub>8</sub> "
Arm height	26 <sup>3</sup> / <sub>8</sub> "
Seat height	18 <sup>1</sup> / <sub>4</sub> "
Seat width	18 <sup>3</sup> / <sub>4</sub> "
Seat depth	18 <sup>3</sup> / <sub>8</sub> "
Kneespace	19"



**Upholstered Back**

► See page 292 to specify.

Height	36 <sup>1</sup> / <sub>4</sub> "
Width	24"
Depth	24 <sup>5</sup> / <sub>8</sub> "
Arm height	26 <sup>3</sup> / <sub>8</sub> "
Seat height	18 <sup>1</sup> / <sub>4</sub> "
Seat width	18 <sup>3</sup> / <sub>4</sub> "
Seat depth	18 <sup>1</sup> / <sub>4</sub> "
Kneespace	19"

# Hero. Just for You.

## Side Chair Models:

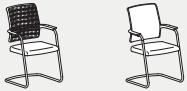

**Side chairs** feature a  $\frac{7}{8}$ " tubular steel frame. Mesh-back construction is the same as desk chair; upholstered back is similar but features 1" CFC- and CHC-free molded foam. Seat cushions are  $1\frac{9}{16}$ " CFC- and CHC-free molded foam. Stackable up to 4 high.

## Options:

**Adjustable lumbar support for mesh-back desk chairs** utilizes a molded polyurethane pad, allowing 2" height and 1" depth adjustments.

**Adjustable lumbar support for upholstered-back desk chairs** utilizes air-pressure technology. Height is adjustable within a  $2\frac{1}{2}$ " range.

**4-D arm option** enables the user to make front-to-back adjustment within a 2" range (7 positions) and 360° pivot (10 positions). Includes the same adjustment features as 2-D arms, as well.

## Overview

### Mesh-back models

incorporate a ribbed design perfectly proportioned to give ergonomically correct, flexible support in all upright or reclined positions. Available in three colors. The mesh is secured to a structural, black plastic frame made of glass-filled polypropylene.

**Seat cushions** are  $2\frac{1}{8}$ " thick— $1\frac{3}{4}$ " CFC- and CHC-free molded foam, plus  $\frac{3}{8}$ " Dacron top pad.

**Fabric or leather upholstery** is unglued, ensuring optimal air movement.

**Seat height** adjusts from  $16\frac{1}{4}$ " to  $22\frac{7}{16}$ " via a patented twist/threaded column adjustment feature and pneumatic (gas) cylinder.

**Black, dual-wheel casters on desk chairs** are 65mm in diameter and available in hard and soft options. Specify hard casters (802) for chairs that will be used on carpeted floors. Specify soft casters (801) for chairs that will be used on hard floors.

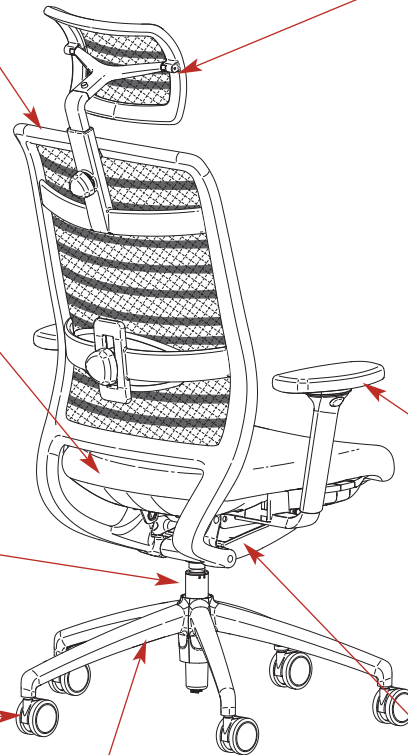

**Headrest** on high-back models is height and depth adjustable—3" range for height and 2" range for depth—and also pivots.

**Upholstered-back models** features a three-piece assembly—a visible, black plastic/polypropylene back with  $\frac{3}{4}$ " CFC- and CHC-free molded foam covered in specified upholstery. The fabric back assembly is then secured to a structural frame made of glass-filled polypropylene.

**T-shaped arm rests** are standard with 2D adjustability. User can adjust the arm vertically within a 4" range (11 positions); technician can adjust the arm horizontally within a  $1\frac{3}{4}$ " range (unlimited positions). Arm caps are black polyurethane.

**Autofit synchro mechanism** with automatic weight regulation and fine adjustment is standard. 126° maximum opening angle between seat and back; can be locked in four positions.

**Five-star base** is available in glass-filled nylon black plastic or cast aluminum in three finish options.

## Adjustability Features:

Synchro-tilt	•
Pneumatic height	•
Swivel	•
Tilt tension	•
Lumbar	◦
Seat depth	◦
Back tilt lock	•
2-D arms	•
4-D arms	◦

• = standard ◦ = option

**Active seat depth adjustment option** provides user with more resting surface for their thighs; 2" adjustment range.

**Anti-kick back feature** controls forward movement of the back rest when the lock is disengaged.

## Weight Rating:

**Desk and side chairs** are user rated up to 275 lbs.

▶ See page

Finishes & Materials	325
Overview	288

Hero.  
Just for You.

## Mesh-Back Desk Chairs

 = Kwik Office model available.  
▶ See the Kwik Office Price List.



Model	Kimball Office Upholstery Pattern						Customer's Own	
	Lucia, King, Globe	Aquarius	Fame	Tinta, Tonica, Bass	Exclusive Leather	Premium Leather	Material (COM)	Leather (COL)
<b>High Back with Arms</b>								
<b>K275H7</b>	\$1929	\$1978	\$2010	\$2118	\$2215	\$2258	\$1929	\$1969
<b>High Back without Arms</b>								
<b>K275H</b>	\$1773	\$1822	\$1854	\$1962	\$2059	\$2102	\$1773	\$1813
<b>Mid-Back with Arms</b>								
<b>K172H7</b> 	\$1721	\$1770	\$1802	\$1910	\$2007	\$2050	\$1721	\$1761
<b>Mid-Back without Arms</b>								
<b>K172H</b>	\$1565	\$1614	\$1646	\$1754	\$1851	\$1894	\$1565	\$1605

### Options:

Description	How to Specify	Add \$ to Price
Adjustable lumbar support	Specify <b>604</b>	+\$85
4-D adjustable arms	Specify <b>709</b>	+\$50
Adjustable seat depth	Specify <b>601</b>	+\$75
Black aluminum base finish	Specify <b>521217</b>	+\$75
Brilliant silver base finish	Specify <b>521234</b>	+\$75
Polished base finish	Specify <b>521304</b>	+\$150

### Specifying Tips:

- Mesh high-back models include mesh headrest in the same color mesh.
- TB133 fire code treatment is available on select upholstery.  
▶ See page 327 for upholstery.  
▶ See page 332 for TB133 pricing.

### How to Specify:

- Model
- Mesh color:  
**8000** = Anthracite  
**8010** = Black  
**8020** = Orange
- Seat upholstery pattern name
- Seat upholstery color designator
- Lumbar support option:  
**604** = Adjustable (+\$)  
**X** = None
- Arm style (omit for armless model):  
**703** = 2D  
**709** = 4D (+\$)
- Seat depth adjustment option:  
**601** = Adjustable (+\$)  
**X** = None
- Base finish designator:  
**532217** = Black plastic  
**521217** = Black aluminum (+\$)  
**521234** = Brilliant silver (+\$)  
**521304** = Polished (+\$)
- Casters:  
**802** = Hard (for use on carpet)  
**801** = Soft (for use on hard floors)

Sample (base model underlined):

K275H7 <sup>①</sup>8000 <sup>②</sup>GLOBE <sup>③</sup>GL01 <sup>④</sup>X  
<sup>⑤</sup>  
<sup>⑥</sup>703 <sup>⑦</sup>601 <sup>⑧</sup>532217 <sup>⑨</sup>802

▶ See page

Finishes & Materials	325
Overview	288

Hero.  
Just for You.

## Upholstered-Back Desk Chairs



Model	Kimball Office Upholstery Pattern						Customer's Own	
	Lucia, King, Globe	Aquarius	Fame	Tinta, Tonica, Bass	Exclusive Leather	Premium Leather	Material (COM)	Leather (COL)
<b>High Back with Arms</b>								
<b>K265H7</b>	\$1841	\$1959	\$2017	\$2213	\$2322	\$2376	\$1841	\$1931
<b>High Back without Arms</b>								
<b>K265H</b>	\$1685	\$1803	\$1861	\$2057	\$2166	\$2220	\$1685	\$1775
<b>Mid-Back with Arms</b>								
<b>K162H7</b>	\$1633	\$1751	\$1809	\$2005	\$2114	\$2168	\$1633	\$1723
<b>Mid-Back without Arms</b>								
<b>K162H</b>	\$1477	\$1595	\$1653	\$1849	\$1958	\$2012	\$1477	\$1567

### Options:

Description	How to Specify	Add \$ to Price
Adjustable lumbar support	Specify <b>604</b>	+\$85
4-D adjustable arms	Specify <b>709</b>	+\$50
Adjustable seat depth	Specify <b>601</b>	+\$75
Black aluminum base finish	Specify <b>521217</b>	+\$75
Brilliant silver base finish	Specify <b>521234</b>	+\$75
Polished base finish	Specify <b>521304</b>	+\$150

### Specifying Tips:

- High-back models include headrest. Models specified with leather back upholstery feature matching leather headrest; models with fabric back upholstery feature black mesh.
- TB133 fire code treatment is available on select upholstery.
  - ▶ See page 327 for upholstery.
  - ▶ See page 332 for TB133 pricing.

### How to Specify:

- Model
- Back upholstery pattern name
- Back upholstery color designator
- Seat upholstery pattern name
- Seat upholstery color designator
- Lumbar support option:  
**604** = Adjustable (+\$)  
**X** = None
- Arm style (omit for armless model):  
**703** = 2D  
**709** = 4D (+\$)
- Seat depth adjustment option:  
**601** = Adjustable (+\$)  
**X** = None
- Base finish designator:  
**532217** = Black plastic  
**521217** = Black aluminum (+\$)  
**521234** = Brilliant silver (+\$)  
**521304** = Polished (+\$)
- Casters:  
**802** = Hard (for use on carpet)  
**801** = Soft (for use on hard floors)

Sample (base model underlined):

<sup>①</sup> K265H7 <sup>②</sup> GLOBE <sup>③</sup> GL01 <sup>④</sup> GLOBE  
<sup>⑤</sup> GL01 <sup>⑥</sup> X <sup>⑦</sup> 703 <sup>⑧</sup> 601 <sup>⑨</sup> 532217 <sup>⑩</sup> 802

Hero.  
Just for You.



## Mesh-Back Stacking Side Chairs

 = Kwik Office model available.  
➤ See the Kwik Office Price List.

Model	Kimball Office Upholstery Pattern						Customer's Own	
	Lucia, King, Globe	Aquarius	Fame	Tinta, Tonica, Bass	Exclusive Leather	Premium Leather	Material (COM)	Leather (COL)
Mesh Back								
<b>K570H</b> 	\$727	\$776	\$808	\$889	\$1013	\$1056	\$727	\$767

### Options:

Description	How to Specify	Add \$ to Price
Chrome frame finish	Specify <b>2324</b>	+\$75
Black felt glides for use on hard floors	Specify <b>821</b>	+\$35

➤ See page

Finishes & Materials	325
Overview	288

### Specifying Tips:

- TB133 fire code treatment is available on select upholstery.  
➤ See page 327 for upholstery.  
➤ See page 332 for TB133 pricing.

### How to Specify:

- ① Model
- ② Mesh color:  
**8000** = Anthracite  
**8010** = Black  
**8020** = Orange
- ③ Seat upholstery pattern name
- ④ Seat upholstery color designator
- ⑤ Frame finish designator:  
**2217** = Black  
**2234** = Brilliant silver  
**2324** = Chrome (+\$)
- ⑥ Glides:  
**821** = Felt (+\$)  
**X** = None

Sample (base model underlined):

① ② ③ ④  
K570H 8000 GLOBE GL01  
⑤ ⑥  
2217 X

▶ See page

Finishes & Materials	325
Overview	288

Hero.  
Just for You.

## Upholstered-Back Stacking Side Chairs



Model	Kimball Office Upholstery Pattern						Customer's Own	
	Lucia, King, Globe	Aquarius	Fame	Tinta, Tonica, Bass	Exclusive Leather	Premium Leather	Material (COM)	Leather (COL)
Upholstered Back								
<b>K550H</b> 	\$711	\$828	\$867	\$1051	\$1142	\$1198	\$711	\$801

### Specifying Tips:

- TB133 fire code treatment is available on select upholstery.
  - ▶ See page 327 for upholstery.
  - ▶ See page 332 for TB133 pricing.

### How to Specify:

- ① Model
- ② Back upholstery pattern name
- ③ Back upholstery color designator
- ④ Seat upholstery pattern name
- ⑤ Seat upholstery color designator
- ⑥ Frame finish designator:
  - 2217** = Black
  - 2234** = Brilliant silver
  - 2324** = Chrome (+\$)
- ⑦ Glides:
  - 821** = Felt (+\$)
  - X** = None

Sample (base model underlined):

① K550H ② GLOBE ③ GL01 ④ GLOBE  
⑤ GL01 ⑥ 2217 ⑦ X

### Options:

Description	How to Specify	Add \$ to Price
Chrome frame finish	Specify <b>2324</b>	+\$75
Black felt glides for use on hard floors	Specify <b>821</b>	+\$35