

## Statement of Line

*A series of possibilities for traditional offices, combining Queen Anne, Georgian and Chippendale influences in lighter-scale furniture for today's management seating needs. Softened edges correspond with the curvature of arms. Backrests are set to provide full support, with armrests sized to allow for pulling close to desks and tables.*

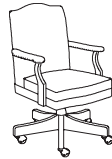

### **Suffolk Desk Chairs**

- See page 102 for product overview.
- See page 103 to specify.

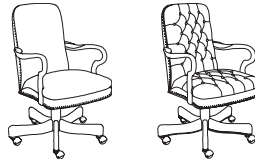

### **Springfield Desk Chairs**

- Available with and without button tufting.
- See page 104 for product overview.
  - See page 105 to specify.



### **Newcastle Desk Chairs**

- See page 106 for product overview.
- See page 107 to specify.

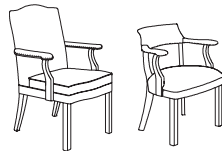

### **Suffolk Side Chairs**

- Available in mid-back or open back models.
- See page 102 for product overview.
  - See page 103 to specify.

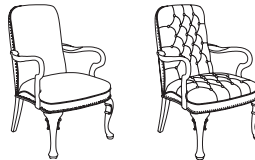

### **Springfield Side Chairs**

- Available with and without button tufting.
- See page 104 for product overview.
  - See page 105 to specify.



### **Newcastle Side Chair**

- See page 106 for product overview.
- See page 107 to specify.



### **Richland Side Chairs**

- Available with and without arms.
- See page 108 for product overview.
  - See page 109 to specify.

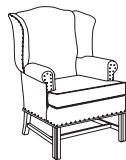

### **Hillsborough Side Chair**

- See page 110 for product overview.
- See page 111 to specify.

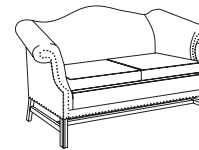

### **Hillsborough Lounge Seating**

- Available in 2-seat and 3-seat models.
- See page 110 for product overview.
  - See page 111 to specify.

# Independence

## Suffolk Overview

### Design Variations:



Mid-Back  
Desk Chair



Mid-Back  
Side Chair



Open Back  
Side Chair

**Three models** are available: mid-back desk, mid-back side, and a complementary open-back side chair.

**Cushions** are high-resiliency, CFC-free polyurethane foam.

**Brass trim nails**, standard on all models, are individually driven head to head around the bottom edge of the upholstered arm caps.

**Antique English hooded ball casters** are standard on desk chair with casters.

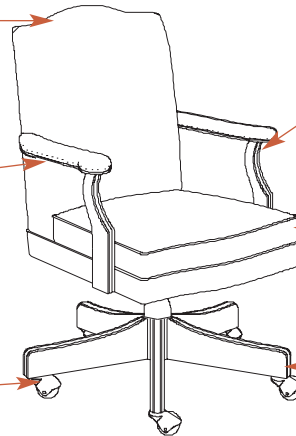

**Arm caps** are upholstered.

**Frame** is kiln-dried hackberry.

**5-prong base** has a rigid steel understructure and hardwood caps with radius ends.

### Features

**Joints** are double doweled and securely glued to ensure maximum strength. Tie screws are added for strength. Seat is reinforced with corner blocks and four screws.

**Side-to-side rails on desk chair** provide strength and a secure place to mount the swivel tilt mechanism.

**Seat suspension** is constructed of unidirectional webbing that is machine stretched across the open frame and stapled to the side rails.

**3" thick seat cushion** is applied to the flexible webbing suspension.

**1½" thick back cushion** is bonded to the hardwood back panel.

**Upholstery** is wrapped over the cushions and secured with upholstery staples.

**Plastic chair guards** protect the outer edges of the upholstery on both sides of the back on the desk chair.

**Swivel tilt mechanism** on desk chair is attached with T-nuts and machine screws.

**Nickel-plated glides** on side chairs are 7/8" in diameter.

### Adjustability Features

#### Desk Chair

|               |   |
|---------------|---|
| Swivel tilt   | • |
| Manual height | • |

• = standard

**Swivel tilt control** allows reclining while keeping the back-to-seat angle constant. It features a heavy-duty adjustable torsion spring.

**Manual height adjustment** allows user to adjust the seat height of an unoccupied chair by turning the bell. Turning the bell clockwise raises the chair; turning the bell counter-clockwise lowers the chair.

### Actual Dimensions:

|                  | Desk     | Side |
|------------------|----------|------|
| <b>Mid-Back</b>  | 82       | 84   |
| Height           | 37"–39¾" | 37"  |
| Width            | 26"      | 26¾" |
| Depth            | 28"      | 27"  |
| Arm height       | 26¼"–29" | 26"  |
| Seat height      | 16"–18¾" | 19½" |
| Seat width       | 19"      | 20¾" |
| Seat depth       | 19"      | 19½" |
| <b>Open Back</b> |          | 81   |
| Height           | —        | 30½" |
| Width            | —        | 25¾" |
| Depth            | —        | 22¾" |
| Arm height       | —        | 26"  |
| Seat height      | —        | 18½" |
| Seat width       | —        | 18½" |
| Seat depth       | —        | 18"  |

# Independence

## Suffolk

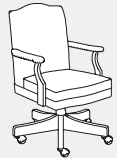

### Kimball Office Upholstery Price Grade

| Model                       | 1 or COM | 2      | 3 or COL | 4      | 5      | 6      | 7      | L7     | L8     |
|-----------------------------|----------|--------|----------|--------|--------|--------|--------|--------|--------|
| <b>Mid-Back Desk Chair</b>  |          |        |          |        |        |        |        |        |        |
| <b>82</b>                   | \$1101   | \$1165 | \$1204   | \$1246 | \$1303 | \$1365 | \$1427 | \$1680 | \$1823 |
| <b>Mid-Back Side Chair</b>  |          |        |          |        |        |        |        |        |        |
| <b>84</b>                   | \$811    | \$875  | \$914    | \$956  | \$1013 | \$1075 | \$1137 | \$1390 | \$1533 |
| <b>Open Back Side Chair</b> |          |        |          |        |        |        |        |        |        |
| <b>81</b>                   | \$768    | \$806  | \$829    | \$854  | \$888  | \$924  | \$960  | \$1110 | \$1194 |

▶ See page

|                          |     |
|--------------------------|-----|
| Finishes & Materials     | 211 |
| COM/COL Yardage Req.     | 248 |
| Alliance Program Pricing | 112 |

### Specifying Tips:

- TB133 fire code treatment is available on select upholstery.
  - ▶ See page 219 for upholstery.
  - ▶ See page 259 for TB133 pricing.
  - ▶ See page 267 for COM or COL.

### How to Specify:

- Model
- Upholstery grade
- Upholstery number
- Finish price group:
  - STD** = Group 1
- Finish designator
- Base (omit for side chairs):
  - B11** = 5-prong base, wood base caps with radius ends
- Casters (omit for side chairs):
  - C44** = Antique English hooded ball casters for desk chair (set of 5)

Sample (base model underlined):

① ② ③ ④ ⑤ ⑥  
82 2 20020 STD MC B11  
 ⑦  
 C44

# Independence

## Springfield Overview

### Design Variations:



Desk chair Side chair  
(plain upholstery)



Desk chair Side chair  
(button-tufted upholstery)

**Button tufting** features hand-pleated diamond tufts on seat and inside back. Metal-prong button unit is pulled through the cover and foam, then inserted through a paperboard washer and a self-locking steel spring retainer and clinched.



**Models with brass trim nails**, with either plain or button-tufted upholstery, are available.

**Frame** is kiln-dried maple hardwoods.

**Brass trim nails**, if selected, are individually driven head to head around the bottom edge of seat and around back.

**5-prong base** has a rigid steel understructure and curved hardwood caps.

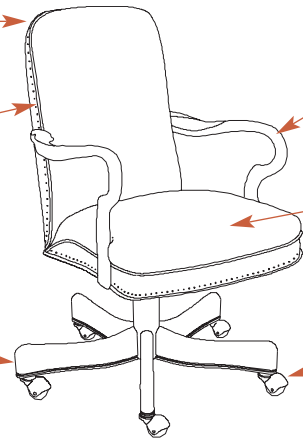

**Arms** are maple hardwoods.

**Cushions** are high resiliency, CFC-free polyurethane foam.

**Antique English hooded ball casters** are standard on desk chairs.

### Features

**Joints** are double doweled and securely glued to ensure maximum strength. Tie screws are added for strength. Seat is reinforced with corner blocks secured with four screws.

**Side-to-side rails on desk chair** provide strength and a secure place to mount the swivel tilt mechanism.

**Seat suspension** is constructed of unidirectional webbing that is machine stretched across the open frame and stapled to the side rails.

**Springfield desk chairs** are suitable for pull-up use in conference settings.

**Seat cushion** is dual density foam applied to the flexible webbing suspension.

**Back suspension** is constructed of four weaves of heavy webbing secured to the frame with staples. A lighter weight webbing is then applied over the four-weave strips. Foam is applied to the suspension.

**Upholstery** is wrapped over the cushions and secured with upholstery staples.

**Swivel tilt mechanism** on desk chair is attached with T-nuts and machine screws.

**Nickel-plated glides** on side chairs are 7/8" in diameter.

### Adjustability Features

#### Desk Chair

|                  |   |
|------------------|---|
| Swivel tilt      | • |
| Pneumatic height | • |

• = standard

**Swivel tilt control** allows reclining while keeping the back-to-seat angle constant. It features a heavy-duty adjustable torsion spring.

**Pneumatic height adjustment** allows user to raise or lower the seat height with a control lever while seated. Up or down movement of lever located beneath the seat activates a gas cylinder to quickly adjust the chair.

### Actual Dimensions:

| Desk Chair  | 972       |
|-------------|-----------|
| Height      | 37¼"-41¼" |
| Width       | 24½"      |
| Depth       | 27½"      |
| Arm height  | 25¾"-29½" |
| Seat height | 18¼"-21½" |
| Seat width  | 18½"      |
| Seat depth  | 18¼"      |
| Side Chair  | 974       |
| Height      | 37¾"      |
| Width       | 23½"      |
| Depth       | 27½"      |
| Arm height  | 26¼"      |
| Seat height | 18½"      |
| Seat width  | 18½"      |
| Seat depth  | 18¼"      |

# Independence

## Springfield



### Kimball Office Upholstery Price Grade

Model 1 or COM 2 3 or COL 4 5 6 7 L7 L8

#### High Back Desk Chairs

##### Plain Upholstery

|            |        |        |        |        |        |        |        |        |        |
|------------|--------|--------|--------|--------|--------|--------|--------|--------|--------|
| <b>972</b> | \$1479 | \$1540 | \$1578 | \$1618 | \$1672 | \$1731 | \$1790 | \$2031 | \$2168 |
|------------|--------|--------|--------|--------|--------|--------|--------|--------|--------|

##### Plain Upholstery with Trim Nails

|             |        |        |        |        |        |        |        |        |        |
|-------------|--------|--------|--------|--------|--------|--------|--------|--------|--------|
| <b>972N</b> | \$1526 | \$1587 | \$1625 | \$1665 | \$1719 | \$1778 | \$1837 | \$2078 | \$2215 |
|-------------|--------|--------|--------|--------|--------|--------|--------|--------|--------|

##### Button Tufted

|             |        |        |        |        |        |        |        |        |        |
|-------------|--------|--------|--------|--------|--------|--------|--------|--------|--------|
| <b>972T</b> | \$1653 | \$1717 | \$1756 | \$1798 | \$1855 | \$1917 | \$1979 | \$2232 | \$2375 |
|-------------|--------|--------|--------|--------|--------|--------|--------|--------|--------|

##### Button Tufted with Trim Nails

|              |        |        |        |        |        |        |        |        |        |
|--------------|--------|--------|--------|--------|--------|--------|--------|--------|--------|
| <b>972TN</b> | \$1697 | \$1761 | \$1800 | \$1842 | \$1899 | \$1961 | \$2023 | \$2276 | \$2419 |
|--------------|--------|--------|--------|--------|--------|--------|--------|--------|--------|

#### Side Chairs

##### Plain Upholstery

|            |        |        |        |        |        |        |        |        |        |
|------------|--------|--------|--------|--------|--------|--------|--------|--------|--------|
| <b>974</b> | \$1264 | \$1325 | \$1363 | \$1403 | \$1457 | \$1516 | \$1575 | \$1816 | \$1953 |
|------------|--------|--------|--------|--------|--------|--------|--------|--------|--------|

##### Plain Upholstery with Trim Nails

|             |        |        |        |        |        |        |        |        |        |
|-------------|--------|--------|--------|--------|--------|--------|--------|--------|--------|
| <b>974N</b> | \$1305 | \$1366 | \$1404 | \$1444 | \$1498 | \$1557 | \$1616 | \$1857 | \$1994 |
|-------------|--------|--------|--------|--------|--------|--------|--------|--------|--------|

##### Button Tufted

|             |        |        |        |        |        |        |        |        |        |
|-------------|--------|--------|--------|--------|--------|--------|--------|--------|--------|
| <b>974T</b> | \$1409 | \$1473 | \$1512 | \$1554 | \$1611 | \$1673 | \$1735 | \$1988 | \$2131 |
|-------------|--------|--------|--------|--------|--------|--------|--------|--------|--------|

##### Button Tufted with Trim Nails

|              |        |        |        |        |        |        |        |        |        |
|--------------|--------|--------|--------|--------|--------|--------|--------|--------|--------|
| <b>974TN</b> | \$1449 | \$1513 | \$1552 | \$1594 | \$1651 | \$1713 | \$1775 | \$2028 | \$2171 |
|--------------|--------|--------|--------|--------|--------|--------|--------|--------|--------|

▶ See page

Finishes & Materials 211

COM/COL Yardage Req. 248

Alliance Program Pricing 112

### Specifying Tips:

- TB133 fire code treatment is available on select upholstery.
  - ▶ See page 219 for upholstery.
  - ▶ See page 259 for TB133 pricing.
  - ▶ See page 267 for COM or COL.

### How to Specify:

- ① Model
- ② Upholstery grade
- ③ Upholstery number
- ④ Finish price group:
  - STD** = Group 1
- ⑤ Finish designator
- ⑥ Base (omit for side chairs):
  - B74** = 5-prong base, curved wood base caps
- ⑦ Casters (omit for side chairs):
  - C44** = Antique English hooded ball casters (set of 5)

Sample (base model underlined):

① ② ③ ④ ⑤ ⑥  
972 2 20020 STD MC B74  
 ⑦  
 C44

# Independence

## Newcastle Overview

### Design Variations:



Desk Chair



Side Chair

**Two models** are available: desk chair and side chair.

**Frame** is kiln-dried maple hardwoods.



**Front of arms** are maple hardwoods with detailing to match the wood base caps.

**Cushions** are dual-density, high resiliency, CFC-free polyurethane foam.

**5-prong base** has a rigid steel understructure and hardwood caps with square ends.

**Antique English hooded ball casters** are standard on desk chairs.

### Features

**Joints** are double doweled and securely glued to ensure maximum strength. Tie screws are added for strength. Seat is reinforced with corner blocks secured with four screws.

**Side-to-side rails on desk chair** provide strength and a secure place to mount the swivel tilt mechanism.

**Seat suspension** is constructed of unidirectional webbing that is machine stretched across the open frame and stapled to the side rails.

**Newcastle desk chairs** are suitable for pull-up use in conference settings.

**Seat cushion** is applied to the flexible webbing suspension.

**Back** is constructed of vertical and horizontal strips of heavy webbing secured to the frame with staples. Foam is applied to the webbing.

**Upholstery** is wrapped over the cushions and secured with upholstery staples.

**Swivel tilt mechanism** on desk chair is attached with machine screws and T-nuts.

**Nylon glides** on side chairs are 7/8" in diameter.

### Adjustability Features

#### Desk Chair

|                  |   |
|------------------|---|
| Swivel tilt      | • |
| Pneumatic height | • |

• = standard

**Swivel tilt control** allows reclining while keeping the back-to-seat angle constant. It features a heavy-duty adjustable torsion spring.

**Pneumatic height adjustment** allows user to raise or lower the seat height with a control lever while seated. Up or down movement of lever located beneath the seat activates a gas cylinder to quickly adjust the chair.

### Actual Dimensions:

| Desk Chair  | 942       |
|-------------|-----------|
| Height      | 32½"-35¾" |
| Width       | 26¼"      |
| Depth       | 27"       |
| Arm height  | 25"-28½"  |
| Seat height | 19½"-22¾" |
| Seat width  | 19½"      |
| Seat depth  | 18¾"      |
| Side Chair  | 944       |
| Height      | 33"       |
| Width       | 26¼"      |
| Depth       | 25½"      |
| Arm height  | 24¾"      |
| Seat height | 19¼"      |
| Seat width  | 19½"      |
| Seat depth  | 18¾"      |

# Independence

## Newcastle



| Model             | <b>Kimball Office Upholstery Price Grade</b> |        |          |        |        |        |        |        |        |  |
|-------------------|--|--------|----------|--------|--------|--------|--------|--------|--------|--|
|                   | 1 or COM                                     | 2      | 3 or COL | 4      | 5      | 6      | 7      | L7     | L8     |  |
| <b>Desk Chair</b> |  |        |          |        |        |        |        |        |        |  |
| <b>942</b>        | \$1377                                       | \$1452 | \$1499   | \$1549 | \$1616 | \$1689 | \$1762 | \$2061 | \$2230 |  |
| <b>Side Chair</b> |  |        |          |        |        |        |        |        |        |  |
| <b>944</b>        | \$1103                                       | \$1178 | \$1225   | \$1275 | \$1342 | \$1415 | \$1488 | \$1787 | \$1956 |  |

▶ See page

|                          |     |
|--------------------------|-----|
| Finishes & Materials     | 211 |
| COM/COL Yardage Req.     | 248 |
| Alliance Program Pricing | 112 |

### Specifying Tips:

- TB133 fire code treatment is available on select upholstery.
  - ▶ See page 219 for upholstery.
  - ▶ See page 259 for TB133 pricing.
  - ▶ See page 267 for COM or COL.
- Faux leather upholstery with TB133 option are not available on Newcastle.

### How to Specify:

- ① Model
- ② Upholstery grade
- ③ Upholstery number
- ④ Finish price group:
  - STD** = Group 1
- ⑤ Finish designator
- ⑥ Base (omit for side chairs):
  - B76** = 5-prong base, wood base caps with square ends
- ⑦ Casters (omit for side chairs):
  - C44** = Antique English hooded ball casters (set of 5)

Sample (base model underlined):

① ② ③ ④ ⑤ ⑥  
942 2 20020 STD MC B76  
 ⑦  
 C44

# Independence

## Richland Overview

### Design Variations:



With arms



Without arms

**Fluted Chippendale splat-back models** are available with or without arms.



With arms



Without arms

**Round Chippendale splat-back models** are available with or without arms.

**Frame** is kiln-dried maple hardwoods.

**Chippendale splat back** features either a fluted or rounded design.

**Legs** are reinforced with stretchers and rails for added durability.

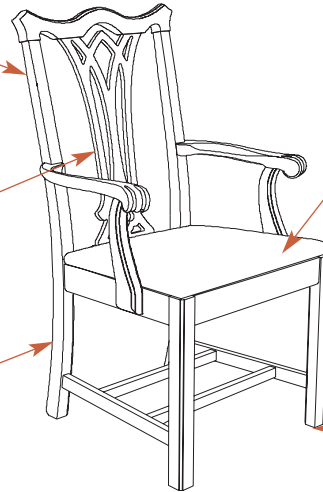

**Cushions** are dual-density, high resiliency, CFC-free polyurethane foam.

**Nylon glides** are 7/8" in diameter.

### Features

**Joints** are double doweled and securely glued to ensure maximum strength. Seat is reinforced with corner blocks secured with eight screws. Leg-to-side rail joint is secured with 1/4"-20 bolt and barrel nut.

**Seat suspension** is constructed of unidirectional webbing that is machine stretched across the open frame and stapled to the side rails.

**Seat cushion** is applied to the flexible webbing suspension.

**Upholstery** is wrapped over the cushion and secured with upholstery staples.

### Actual Dimensions:

| <b>With Arms</b>    |  | 995 & 996 |
|---------------------|--|-----------|
| Height              |  | 39 3/4"   |
| Width               |  | 23 1/4"   |
| Depth               |  | 22 1/2"   |
| Arm height          |  | 25 3/4"   |
| Seat height         |  | 19 3/8"   |
| Seat width          |  | 18 1/2"   |
| Seat depth          |  | 17 1/2"   |
| <b>Without Arms</b> |  | 997 & 998 |
| Height              |  | 39 3/4"   |
| Width               |  | 20 1/4"   |
| Depth               |  | 22 1/2"   |
| Seat height         |  | 19 3/8"   |
| Seat width          |  | 18 5/8"   |
| Seat depth          |  | 17 1/2"   |

# Independence

## Richland

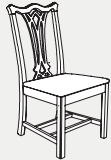

### Kimball Office Upholstery Price Grade

| Model                                | 1 or COM | 2     | 3 or COL | 4      | 5      | 6      | 7      | L7     | L8     |
|--------------------------------------|----------|-------|----------|--------|--------|--------|--------|--------|--------|
| <b>Fluted Chippendale Splat Back</b> |          |       |          |        |        |        |        |        |        |
| <i>With Arms</i>                     |          |       |          |        |        |        |        |        |        |
| <b>995</b>                           | \$970    | \$990 | \$1003   | \$1016 | \$1034 | \$1054 | \$1074 | \$1154 | \$1200 |
| <i>Armless</i>                       |          |       |          |        |        |        |        |        |        |
| <b>997</b>                           | \$827    | \$847 | \$860    | \$873  | \$891  | \$911  | \$931  | \$1011 | \$1057 |

### Round Chippendale Splat Back

|                  |        |        |        |        |        |        |        |        |        |
|------------------|--------|--------|--------|--------|--------|--------|--------|--------|--------|
| <i>With Arms</i> |        |        |        |        |        |        |        |        |        |
| <b>996</b>       | \$1092 | \$1112 | \$1125 | \$1138 | \$1156 | \$1176 | \$1196 | \$1276 | \$1322 |
| <i>Armless</i>   |        |        |        |        |        |        |        |        |        |
| <b>998</b>       | \$946  | \$966  | \$979  | \$992  | \$1010 | \$1030 | \$1050 | \$1130 | \$1176 |

▶ See page

|                          |     |
|--------------------------|-----|
| Finishes & Materials     | 211 |
| COM/COL Yardage Req.     | 248 |
| Alliance Program Pricing | 112 |

### Specifying Tips:

- TB133 fire code treatment is available on select upholstery.
  - ▶ See page 219 for upholstery.
  - ▶ See page 259 for TB133 pricing.
  - ▶ See page 267 for COM or COL.

### How to Specify:

- ① Model
- ② Upholstery grade
- ③ Upholstery number
- ④ Finish price group:  
**STD** = Group 1
- ⑤ Finish designator

Sample (base model underlined):

995 ① ② ③ ④ ⑤ 2 20020 STD MC

# Independence

## Hillsborough Overview

### Design Variations:



Side Chair



2-Seat Lounge



3-Seat Lounge

**Frame** is kiln-dried maple hardwoods.

**Brass trim nails** are individually driven head to head around the bottom edge of seat and on the front of rolled arm.

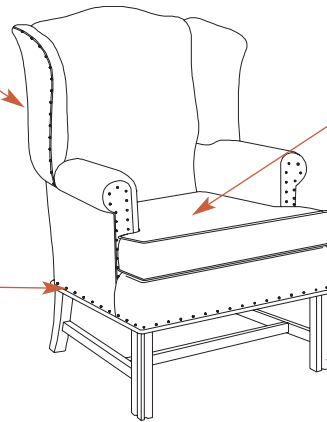

**Cushions** are high resiliency, CFC-free polyurethane foam.

**Legs** are reinforced with stretchers and rails for added durability.

### Features

**Joints** are double doweled and securely glued to ensure maximum strength. Tie screws are added for strength. Seat is reinforced with support rails and corner blocks secured with four screws for extreme rigidity and strength.

**Seat suspension** is constructed with pre-assembled high carbon, high tensile, hand drawn drop-in coil spring units, covered with a high-quality woven webbing. A 1/4" insulator pad is applied over the seat suspension. Denim material is upholstered over the pad.

**Removable seat cushions** have 4 1/4" of bonded foam on side chair, 4" of bonded foam on 2-seat and 3-seat lounge.

**Back suspension** is constructed of five 11" gauge sinuous springs that are suspended from the frame by metal clips. Springs are tied together with a strong steel-resistant wrapping.

**Back cushion** is 3" thick and is supported with a layer of high-quality woven webbing covering the back suspension. Rails are padded with foam for additional cushioning.

**Upholstery** is wrapped over the cushions and secured with upholstery staples.

**Nickel-plated glides** are 7/8" in diameter.

### Actual Dimensions:

|                      |         |
|----------------------|---------|
| <b>Side Chair</b>    | 956     |
| Height               | 42 3/4" |
| Width                | 31 1/2" |
| Depth                | 32"     |
| Arm height           | 26"     |
| Seat height          | 19"     |
| Seat width           | 19 1/4" |
| Seat depth           | 19 3/4" |
| <b>2-Seat Lounge</b> | 957     |
| Height               | 35"     |
| Width                | 64"     |
| Depth                | 32"     |
| Arm height           | 28 1/2" |
| Seat height          | 18"     |
| Seat width           | 42"     |
| Seat depth           | 21"     |
| <b>3-Seat Lounge</b> | 958     |
| Height               | 36 1/2" |
| Width                | 88"     |
| Depth                | 32"     |
| Arm height           | 28 1/2" |
| Seat height          | 18"     |
| Seat width           | 68"     |
| Seat depth           | 21"     |

# Independence

## Hillsborough

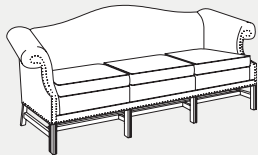
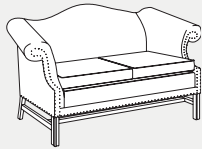
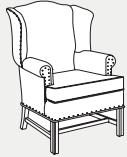

### Kimball Office Upholstery Price Grade

| Model             | 1 or COM | 2      | 3 or COL | 4      | 5      | 6      | 7      | L7     | L8     |
|-------------------|----------|--------|----------|--------|--------|--------|--------|--------|--------|
| <b>Wing Chair</b> |          |        |          |        |        |        |        |        |        |
| <b>956</b>        | \$1627   | \$1769 | \$1857   | \$1950 | \$2078 | \$2215 | \$2352 | \$2916 | \$3234 |

| <b>Camel-Back 2-Seat Lounge</b> |        |        |        |        |        |        |        |        |        |
|---------------------------------|--------|--------|--------|--------|--------|--------|--------|--------|--------|
| <b>957</b>                      | \$2512 | \$2718 | \$2846 | \$2981 | \$3165 | \$3364 | \$3563 | \$4379 | \$4841 |

| <b>Camel-Back 3-Seat Lounge</b> |        |        |        |        |        |        |        |        |        |
|---------------------------------|--------|--------|--------|--------|--------|--------|--------|--------|--------|
| <b>958</b>                      | \$3048 | \$3338 | \$3518 | \$3708 | \$3968 | \$4248 | \$4528 | \$5678 | \$6328 |

➤ See page

|                          |     |
|--------------------------|-----|
| Finishes & Materials     | 211 |
| COM/COL Yardage Req.     | 248 |
| Alliance Program Pricing | 112 |

### Specifying Tips:

- TB133 fire code treatment is available on select upholstery.
  - See page 219 for upholstery.
  - See page 259 for TB133 pricing.
  - See page 267 for COM or COL.
- Faux leather upholstery with TB133 option are not available on Hillsborough wing chairs and lounges.

### How to Specify:

- ① Model
- ② Upholstery grade
- ③ Upholstery number
- ④ Finish price group:  
**STD** = Group 1
- ⑤ Finish designator

Sample (base model underlined):

① ② ③ ④ ⑤  
996 2 20020 STD MC

# Independence

**IMPORTANT:** Orders cannot be cancelled for chairs specified with Alliance Program upholstery.

## with Alliance Program Upholstery

| Model              | Alliance Upholstery Price Grade |        |        |        |        |        |        |        |        |  |
|--------------------|---------------------------------|--------|--------|--------|--------|--------|--------|--------|--------|--|
|                    | A                               | B      | C      | D      | E      | F      | G      | H      | I      |  |
|                    | J                               | K      | L      | M      | N      | O      | P      | Q      | R      |  |
| <b>Desk Chairs</b> |                                 |        |        |        |        |        |        |        |        |  |
| <b>82</b>          | \$1198                          | \$1240 | \$1277 | \$1310 | \$1352 | \$1396 | \$1424 | \$1471 | \$1515 |  |
|                    | 1554                            | 1622   | 1761   | 1849   | 1860   | 1882   | 1904   | 1926   | 2018   |  |
| <b>942</b>         | 1491                            | 1541   | 1585   | 1624   | 1673   | 1725   | 1759   | 1814   | 1866   |  |
|                    | 1913                            | 1993   | 2157   | 2261   | 2274   | 2300   | 2326   | 2352   | 2461   |  |
| <b>972</b>         | 1571                            | 1611   | 1647   | 1679   | 1718   | 1760   | 1788   | 1832   | 1874   |  |
|                    | 1912                            | 1977   | 2109   | 2193   | 2204   | 2225   | 2246   | 2267   | 2355   |  |
| <b>972N</b>        | 1618                            | 1658   | 1694   | 1726   | 1765   | 1807   | 1835   | 1879   | 1921   |  |
|                    | 1959                            | 2024   | 2156   | 2240   | 2251   | 2272   | 2293   | 2314   | 2402   |  |
| <b>972T</b>        | 1750                            | 1792   | 1829   | 1862   | 1904   | 1948   | 1976   | 2023   | 2067   |  |
|                    | 2106                            | 2174   | 2313   | 2401   | 2412   | 2434   | 2456   | 2478   | 2570   |  |
| <b>972TN</b>       | 1794                            | 1836   | 1873   | 1906   | 1948   | 1992   | 2020   | 2067   | 2111   |  |
|                    | 2150                            | 2218   | 2357   | 2445   | 2456   | 2478   | 2500   | 2522   | 2614   |  |

### Specifying Tips:

- TB133 fire code treatment is available on select upholstery. See page 267 for program overview.

### How to Specify:

- Model
- Alliance partner designator and upholstery grade:  
**CAR**[grade] = Carnegie  
**KNL**[grade] = KnollTextiles  
**MHM**[grade] = Maharam  
**MAF**[grade] = Mayer Fabrics
- Upholstery number
- Finish price group:  
**STD** = Group 1
- Finish designator
- Base:  
**B11** = Base for Suffolk  
**B74** = Base for Springfield  
**B76** = Base for Newcastle
- Casters:  
**C44** = Antique English hooded ball casters (set of 5)

Sample (base model underlined):

① ② ③ ④ ⑤  
82 CARJ 6136\_10 STD MC  
 ⑥ ⑦  
 B11 C44

# Independence

**IMPORTANT:** Orders cannot be cancelled for chairs specified with Alliance Program upholstery.

## with Alliance Program Upholstery, continued

| Model              | Alliance Upholstery Price Grade |       |       |       |       |       |       |       |        |  |
|--------------------|---------------------------------|-------|-------|-------|-------|-------|-------|-------|--------|--|
|                    | A                               | B     | C     | D     | E     | F     | G     | H     | I      |  |
|                    | J                               | K     | L     | M     | N     | O     | P     | Q     | R      |  |
| <b>Side Chairs</b> |                                 |       |       |       |       |       |       |       |        |  |
| <b>81</b>          | \$825                           | \$850 | \$872 | \$892 | \$916 | \$942 | \$959 | \$986 | \$1012 |  |
|                    | 1036                            | 1076  | 1158  | 1210  | 1217  | 1230  | 1243  | 1256  | 1310   |  |
| <b>84</b>          | 908                             | 950   | 987   | 1020  | 1062  | 1106  | 1134  | 1181  | 1225   |  |
|                    | 1264                            | 1332  | 1471  | 1559  | 1570  | 1592  | 1614  | 1636  | 1728   |  |
| <b>944</b>         | 1217                            | 1267  | 1311  | 1350  | 1399  | 1451  | 1485  | 1540  | 1592   |  |
|                    | 1639                            | 1719  | 1883  | 1987  | 2000  | 2026  | 2052  | 2078  | 2187   |  |
| <b>974</b>         | 1356                            | 1396  | 1432  | 1464  | 1503  | 1545  | 1573  | 1617  | 1659   |  |
|                    | 1697                            | 1762  | 1894  | 1978  | 1989  | 2010  | 2031  | 2052  | 2140   |  |
| <b>974N</b>        | 1397                            | 1437  | 1473  | 1505  | 1544  | 1586  | 1614  | 1658  | 1700   |  |
|                    | 1738                            | 1803  | 1935  | 2019  | 2030  | 2051  | 2072  | 2093  | 2181   |  |
| <b>974T</b>        | 1506                            | 1548  | 1585  | 1618  | 1660  | 1704  | 1732  | 1779  | 1823   |  |
|                    | 1862                            | 1930  | 2069  | 2157  | 2168  | 2190  | 2212  | 2234  | 2326   |  |
| <b>974TN</b>       | 1546                            | 1588  | 1625  | 1658  | 1700  | 1744  | 1772  | 1819  | 1863   |  |
|                    | 1902                            | 1970  | 2109  | 2197  | 2208  | 2230  | 2252  | 2274  | 2366   |  |
| <b>995</b>         | 1001                            | 1014  | 1026  | 1037  | 1050  | 1064  | 1073  | 1088  | 1102   |  |
|                    | 1114                            | 1136  | 1180  | 1208  | 1212  | 1219  | 1226  | 1233  | 1262   |  |
| <b>996</b>         | 1123                            | 1136  | 1148  | 1159  | 1172  | 1186  | 1195  | 1210  | 1224   |  |
|                    | 1236                            | 1258  | 1302  | 1330  | 1334  | 1341  | 1348  | 1355  | 1384   |  |
| <b>997</b>         | 858                             | 871   | 883   | 894   | 907   | 921   | 930   | 945   | 959    |  |
|                    | 971                             | 993   | 1037  | 1065  | 1069  | 1076  | 1083  | 1090  | 1119   |  |
| <b>998</b>         | 977                             | 990   | 1002  | 1013  | 1026  | 1040  | 1049  | 1064  | 1078   |  |
|                    | 1090                            | 1112  | 1156  | 1184  | 1188  | 1195  | 1202  | 1209  | 1238   |  |

### Specifying Tips:

- TB133 fire code treatment is available on select upholstery.
- ▶ See page 267 for program overview.

### How to Specify:

- ① Model
- ② Alliance partner designator and upholstery grade:  
**CAR**[grade] = Carnegie  
**KNL**[grade] = KnollTextiles  
**MHM**[grade] = Maharam  
**MAF**[grade] = Mayer Fabrics
- ③ Upholstery number
- ④ Finish price group:  
**STD** = Group 1
- ⑤ Finish designator

Sample (base model underlined):

① ② ③ ④ ⑤  
84 CARJ 6136\_10 STD MC

# Independence

## with Alliance Program Upholstery, continued

| Model                 | <b>Alliance Upholstery Price Grade</b> |        |        |        |        |        |        |        |        |  |
|-----------------------|--|--------|--------|--------|--------|--------|--------|--------|--------|--|
|                       | A                                      | B      | C      | D      | E      | F      | G      | H      | I      |  |
|                       | J                                      | K      | L      | M      | N      | O      | P      | Q      | R      |  |
| <b>Lounge Seating</b> |  |        |        |        |        |        |        |        |        |  |
| <b>956</b>            | \$1843                                 | \$1936 | \$2019 | \$2093 | \$2186 | \$2284 | \$2347 | \$2450 | \$2548 |  |
|                       | 2636                                   | 2788   | 3097   | 3293   | 3318   | 3367   | 3416   | 3465   | 3670   |  |
| <b>957</b>            | 2824                                   | 2959   | 3080   | 3187   | 3321   | 3463   | 3556   | 3705   | 3847   |  |
|                       | 3975                                   | 4195   | 4642   | 4926   | 4962   | 5033   | 5104   | 5175   | 5473   |  |
| <b>958</b>            | 3488                                   | 3678   | 3848   | 3998   | 4188   | 4388   | 4518   | 4728   | 4928   |  |
|                       | 5108                                   | 5418   | 6048   | 6448   | 6498   | 6598   | 6698   | 6798   | 7218   |  |

### Specifying Tips:

- TB133 fire code treatment is available on select upholstery. See page 267 for program overview.

### How to Specify:

- ① Model
- ② Alliance partner designator and upholstery grade:  
**CAR**[grade] = Carnegie  
**KNL**[grade] = KnollTextiles  
**MHM**[grade] = Maharam  
**MAF**[grade] = Mayer Fabrics
- ③ Upholstery number
- ④ Finish price group:  
**STD** = Group 1
- ⑤ Finish designator

Sample (base model underlined):

① ② ③ ④ ⑤  
956 CARJ 6136\_10 STD MC