

Statement of Line

Vista, available in an array of upholstery selections, complements any office or reception area and offers styling that ranges from traditional to transitional to contemporary, with a choice of one-, two- or three-seat models.

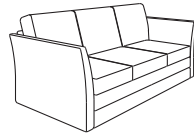

Vista 3-Seat Lounge

Available with or without legs.

▶ See page 185 to specify.

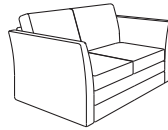

Vista 2-Seat Lounge

Available with or without legs.

▶ See page 185 to specify.

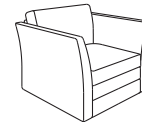

Vista 1-Seat Lounge

Available with or without legs.

▶ See page 185 to specify.

▶ See page

Finishes & Materials	211
Overview	184
Actual Dimensions	184

Vista

Overview

Design Variations:

Vista is available in 3-, 2-, and 1-seat models and with or without piping.

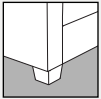

Models with legs are available on all sizes. Wood finishes are standard.

Options:

Contrasting upholstery is available on models without piping. Back and seat upholstery applies to the cushions; arms and frame upholstery applies to remainder of the lounge model.

Contrasting piping may be specified on applicable models in Kimball Office fabric or leather.

Frame is constructed of 7/8" plywood.

Cushions are high resiliency, CFC-free polyurethane foam.

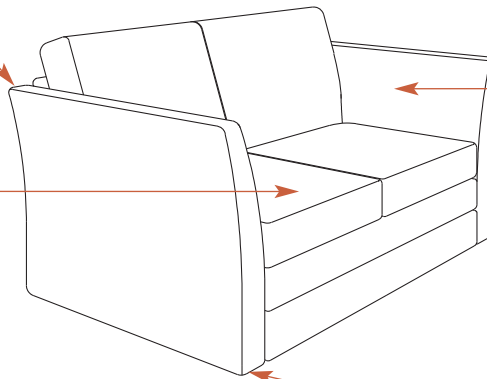

All models are fully upholstered.

Non-skid glides are 1³/₄" in diameter and adjustable.

Features

Seats have a high resiliency sheet webbing suspension that is stapled to the frame. Frame construction meets or exceeds GSA Heavy Duty Testing requirements.

Seat cushions are removable and feature 7" of dual density, custom shaped foam. Each cushion is 22"W, slipcovered, and closed with zippers.

Back features a non-stretch woven suspension that is stapled to the frame.

Back cushions are attached and feature 5¹/₂" of dual density, custom shaped foam.

Armrest frames are wrapped with 1/2" high density foam, slipcovered, and attached to units with three 7/16" carriage bolts per arm.

Legs, on applicable models, are kiln-dried select hardwoods and are attached using three wood screws. Each leg contains a non-skid adjustable glide.

All models are fully upholstered. Bottom is finished with a black fabric dust cover.

Actual Dimensions:

	3- Seat	2- Seat	1- Seat
Height	31"	31"	31"
Width	81 ¹ / ₄ "	59 ¹ / ₄ "	37 ¹ / ₄ "
Depth	33 ³ / ₄ "	33 ³ / ₄ "	33 ³ / ₄ "
Arm height	26 ¹ / ₂ "	26 ¹ / ₂ "	26 ¹ / ₂ "
Seat height	17 ³ / ₄ "	17 ³ / ₄ "	17 ³ / ₄ "
Seat width	66 ¹ / ₂ "	44 ¹ / ₂ "	22 ¹ / ₂ "
Seat depth	21"	21"	21"

▶ See page

Finishes & Materials	211
COM/COL Yardage Req.	250
Alliance Program Pricing	187

Vista

Lounge Seating With Piping

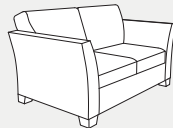
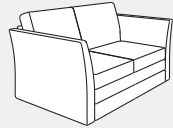

Kimball Office Upholstery Price Grade

Model	1 or COM	2	3 or COL	4	5	6	7	L7	L8
Without Legs									
<i>3-Seat Lounge</i>									
1746	\$3135	\$3518	\$3755	\$4006	\$4349	\$4719	\$5089	\$6607	\$7465
<i>2-Seat Lounge (shown)</i>									
1744	\$2450	\$2772	\$2972	\$3183	\$3471	\$3782	\$4093	\$5369	\$6091
<i>1-Seat Lounge</i>									
1742	\$1860	\$2080	\$2217	\$2362	\$2559	\$2772	\$2985	\$3859	\$4353
Wood Finished Legs									
<i>3-Seat Lounge</i>									
1746LW	\$3245	\$3628	\$3865	\$4116	\$4459	\$4829	\$5199	\$6717	\$7575
<i>2-Seat Lounge (shown)</i>									
1744LW	\$2562	\$2884	\$3084	\$3295	\$3583	\$3894	\$4205	\$5481	\$6203
<i>1-Seat Lounge</i>									
1742LW	\$1971	\$2191	\$2328	\$2473	\$2670	\$2883	\$3096	\$3970	\$4464

Specifying Tips:

- TB133 fire code treatment is available on select upholstery.
 - ▶ See page 219 for upholstery.
 - ▶ See page 263 for TB133 pricing.
 - ▶ See page 267 for COM or COL.

How to Specify:

- Model
- Upholstery** (primary):
 - Upholstery grade
 - Upholstery number
- Piping:**
 - Upholstery grade
 - Upholstery number
- Finish** (omit for models without legs):
 - Finish price group: **STD** = Group 1
 - Finish designator

Sample (base model underlined):

① ② ③ ④ ⑤
1746LW 2 20020 2 20039
 ⑥ ⑦
 STD MC

Note: Contrasting upholstery option is not available on Vista models with piping.

Options:

Description	How to Specify	Add/Deduct \$
Contrasting piping	Specify a different fabric or leather for piping IMPORTANT: Available in Kimball Office fabric or leather only.	Use electronic specification tool

Vista Lounge Seating Without Piping

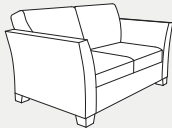
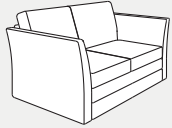

Model	Kimball Office Upholstery Price Grade								
	1 or COM	2	3 or COL	4	5	6	7	L7	L8
Without Legs									
<i>3-Seat Lounge</i>									
1756	\$3044	\$3395	\$3613	\$3843	\$4157	\$4496	\$4835	\$6226	\$7013
<i>2-Seat Lounge (shown)</i>									
1754	\$2391	\$2695	\$2885	\$3084	\$3357	\$3651	\$3945	\$5152	\$5835
<i>1-Seat Lounge</i>									
1752	\$1796	\$2004	\$2134	\$2271	\$2458	\$2660	\$2861	\$3690	\$4158
Wood Finished Legs									
<i>3-Seat Lounge</i>									
1756LW	\$3155	\$3506	\$3724	\$3954	\$4268	\$4607	\$4946	\$6337	\$7124
<i>2-Seat Lounge (shown)</i>									
1754LW	\$2503	\$2807	\$2997	\$3196	\$3469	\$3763	\$4057	\$5264	\$5947
<i>1-Seat Lounge</i>									
1752LW	\$1908	\$2116	\$2246	\$2383	\$2570	\$2772	\$2973	\$3802	\$4270

Options:

Description	How to Specify	Add/Deduct \$
Contrasting upholstery ➤ See page 226.	Specify different fabric or leather for back/seat and arm/frame	Use electronic specification tool for accurate pricing

➤ See page

Finishes & Materials	211
COM/COL Yardage Req.	250
Alliance Program Pricing	187

Specifying Tips:

- TB133 fire code treatment is available on select upholstery.
➤ See page 219 for upholstery.
➤ See page 263 for TB133 pricing.
➤ See page 267 for COM or COL.

How to Specify:

- Model
- Back and seat upholstery:**
 - Upholstery grade
 - Upholstery number
- Arm/frame upholstery** (primary):
 - Upholstery grade
 - Upholstery number
- Finish** (include for LW models only):
 - Finish price group: **STD** = Group 1
 - Finish designator

Sample (base model underlined):

① ② ③ ④ ⑤
1756LW 2 20020 2 20039
 ⑥ ⑦
 STD MC

Vista

with Alliance Program Upholstery

IMPORTANT: Orders cannot be cancelled for chairs specified with Alliance Program upholstery.

Model	Alliance Upholstery Price Grade									
	A	B	C	D	E	F	G	H	I	
	J	K	L	M	N	O	P	Q	R	
Vista with Piping										
1742	\$2194	\$2339	\$2468	\$2582	\$2726	\$2878	\$2977	\$3137	\$3289	
	3426	3661	4140	4444	4482	4558	4634	4710	5029	
1742LW	2305	2450	2579	2693	2837	2989	3088	3248	3400	
	3537	3772	4251	4555	4593	4669	4745	4821	5140	
1744	2938	3149	3338	3505	3715	3937	4082	4315	4537	
	4737	5081	5780	6224	6280	6391	6502	6613	7079	
1744LW	3050	3261	3450	3617	3827	4049	4194	4427	4649	
	4849	5193	5892	6336	6392	6503	6614	6725	7191	
1746	3716	3967	4191	4389	4640	4904	5075	5353	5617	
	5854	6263	7095	7623	7689	7821	7953	8085	8639	
1746LW	3826	4077	4301	4499	4750	5014	5185	5463	5727	
	5964	6373	7205	7733	7799	7931	8063	8195	8749	

Options:

Description	How to Specify	Add/Deduct \$
Contrasting piping	Specify a different fabric or leather for piping IMPORTANT: Available in Kimball Office fabric or leather only.	Use electronic specification tool

Note: Contrasting upholstery option is not available on Vista models with piping.
➤ See page 226.

Specifying Tips:

- TB133 fire code treatment is available on select upholstery.
➤ See page 267 for program overview.

How to Specify:

- ① Model
- ② **Upholstery** (primary):
Alliance partner designator and upholstery grade:
CAR[grade] = Carnegie
KNL[grade] = KnollTextiles
MHM[grade] = Maharam
MAF[grade] = Mayer Fabrics
- ③ Upholstery number
- ④ **Piping:**
If same, Alliance partner designator and upholstery grade (see above); if contrasting, Kimball Office upholstery grade
- ⑤ Upholstery number
- ⑥ **Finish** (Include for LW models only):
Finish price group:
STD = Group 1
- ⑦ Finish designator

Sample (base model underlined):
① ② ③
1746LW CARJ 6136_10
④ ⑤ ⑥ ⑦
2 20020 STD MC

Vista

with Alliance Program Upholstery, continued

IMPORTANT: Orders cannot be cancelled for chairs specified with Alliance Program upholstery.

Model	Alliance Upholstery Price Grade									
	A	B	C	D	E	F	G	H	I	
	J	K	L	M	N	O	P	Q	R	
Vista without Piping										
1752	\$2113	\$2250	\$2372	\$2480	\$2617	\$2761	\$2854	\$3005	\$3150	
	3279	3502	3956	4244	4280	4352	4424	4496	4798	
1752LW	2225	2362	2484	2592	2729	2873	2966	3117	3262	
	3391	3614	4068	4356	4392	4464	4536	4608	4910	
1754	2853	3052	3231	3388	3588	3798	3935	4155	4365	
	4554	4880	5541	5961	6014	6118	6223	6328	6769	
1754LW	2965	3164	3343	3500	3700	3910	4047	4267	4477	
	4666	4992	5653	6073	6126	6230	6335	6440	6881	
1756	3577	3806	4012	4194	4423	4665	4823	5077	5319	
	5537	5912	6674	7158	7218	7340	7460	7582	8090	
1756LW	3688	3917	4123	4305	4534	4776	4934	5188	5430	
	5648	6023	6785	7269	7329	7451	7571	7693	8201	

Options:

Description	How to Specify	Add/Deduct \$
Contrasting upholstery	Specify different fabric or leather for back/seat and arm/frame	Use electronic specification tool

Specifying Tips:

- TB133 fire code treatment is available on select upholstery. ▶ See page 267 for program overview.

How to Specify:

- ① Model
- ② **Back and seat upholstery:** Alliance partner designator and upholstery grade:
CAR[grade] = Carnegie
KNL[grade] = KnollTextiles
MHM[grade] = Maharam
MAF[grade] = Mayer Fabrics
- ③ Upholstery number
- ④ **Arm/frame upholstery** (primary): Alliance partner designator and upholstery grade (see above)
- ⑤ Upholstery number
- ⑥ **Finish** (Include for LW models only): Finish price group:
STD = Group 1
- ⑦ Finish designator

Sample (base model underlined):

① ② ③
1756LW CARJ 6136_10
 ④ ⑤ ⑥ ⑦
 CARJ 6136_10 STD MC