

Statement of Line

Ships In
10
Days

➤ See page

Overview	106
Filing Capabilities	107

Options:

All available options on Kwik Office models are listed on the individual pricing pages.

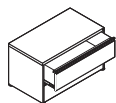

Two-High Lateral Files

- Two drawers
- See page 108.

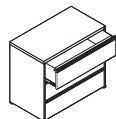

Three-High Lateral Files

- Three drawers
- See page 108.

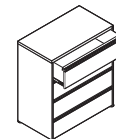

Four-High Lateral Files

- Four drawers
- See page 108.

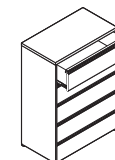

Five-High Lateral Files

- Five drawers
- Four drawers and one fixed shelf with lift door.
- Five drawers, ADA compliant
- See page 109.

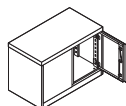

Overfiles

- See page 109.

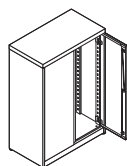

Storage Cabinets

- Two high
- Three high
- Four high
- Five high
- See page 110.

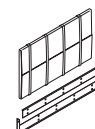

Counterweight Kits

- See page 111.



Overfile/Storage Cabinet Shelves and Wardrobe Kits

- See page 111.

Overview

Pulls:

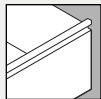

Extended drawer pull is recessed along the full front edge. It is painted the same color as the unit.

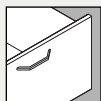

Rail pull is textured black.

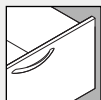

Arc pull is available in 462 Cinder.

Top is finished so the file can be used as a stand alone unit.

Knockouts are standard for ganging side by side.

Fixed shelf with lift door on applicable five-high lateral files replaces top drawer and accommodates standing binders up to 12"H.

Counterweight kit, specified separately, is required for all individual freestanding units. Kits include counterweight and bracket, packaged individually.

Four glides, standard, provide 1" adjustability and allow for sturdy, four-point loading.

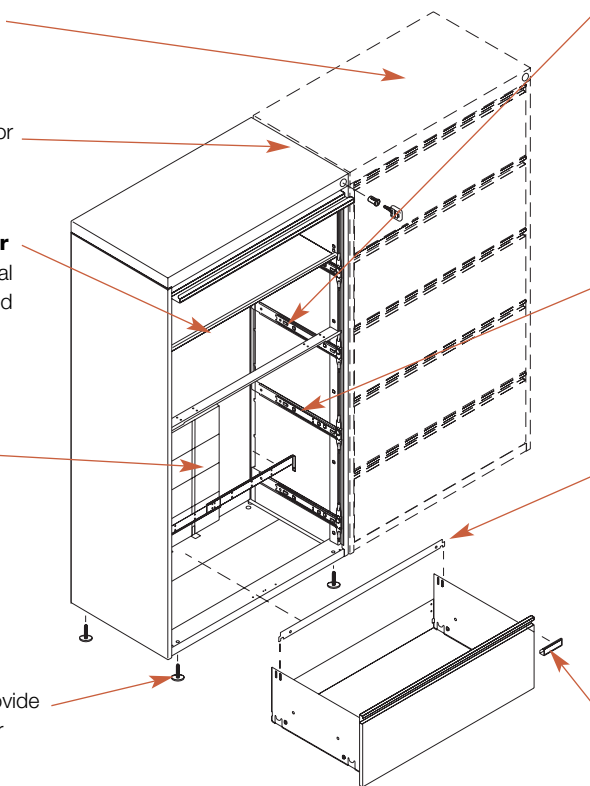

Integrated drawer slide and single interlock mechanism is part of the slide design, providing for quieter drawer operation and ensuring only one drawer may be opened at a time.

Full ball-bearing drawer suspension allows both the drawer and suspension to extend together.

Side-to-side file bar is standard; one per drawer.

Front-to-back file bars are available separately for easy field installation.

Label holder is standard; one per drawer.

Features

Right angle bend of the coach seam makes the strongest use of formed metal and presents a clean exterior with no exposed welds.

Progressive-slide suspension provides smooth drawer operation.

Steel drawer interiors are pre-painted cinder.

ADA-compliant lateral files feature the choice of rail or arc pull. The lock is placed at 38⁵/₈"H, making it accessible from a seated position.

Drawer fronts and lift doors in the top position on five-high lateral files are 1⁹/₁₆" taller than the other drawer fronts to accommodate the receding lift-door application.

Locks:

Lateral files are predrilled to accept lock cores. Lock secures all drawers in the unit. Select key random or key specific when specifying.

Keying:

Key Random Option

Key numbers will be assigned arbitrarily at the factory with key numbers ranging from QKSCD001 to QKSCD025. Locks are shipped separately for field installation.

Key Specific Option

Specify any key number between QKSCD001 and QKSCD025. Locks are shipped separately for field installation.

IMPORTANT: If you select the key specific option, you must specify the lock core separately.

➤ See page 113.

Filing Capabilities

Filing Reference:







- Legal size paper is 8½" x 14".
- Letter size paper is 8½" x 11".
- EDP size paper is 8½" x 147⁄8".

Filing Hardware:

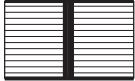
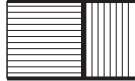
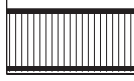
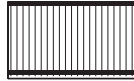
Heavier lines in the illustrations at right indicate filing hardware.

Front-to-back file bars can be specified separately.
 ➤ See page 112.

Side-to-side file bar is standard; one per drawer.
 ➤ See page 112.

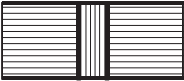
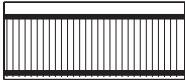
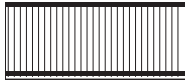
Description	Inside Depth	Inside Width	Height	Filing Arrangements							
18"D x 30"W lateral	147⁄8"	267⁄8"	93⁄8"					295⁄8" letter Front-to-back file bars (2) Side-to-side file bars (2)	25¼" legal Front-to-back file bar (1) Side-to-side file bars (2)	2613⁄16" letter Side-to-side file bars (2)	2613⁄16" legal Side-to-side file bars (2)
18"D x 36"W lateral	147⁄8"	327⁄8"	93⁄8"					295⁄8" letter Front-to-back file bars (2) Side-to-side file bars (2)	295⁄8" legal Front-to-back file bars (2) Side-to-side file bars (2)	3213⁄16" letter Side-to-side file bars (2)	3213⁄16" legal Side-to-side file bars (2)
18"D x 42"W lateral	147⁄8"	387⁄8"	93⁄8"					447⁄16" letter Front-to-back file bar (2) Side-to-side file bars (2)	355⁄8" legal Front-to-back file bars (2) Side-to-side file bars (2)	3813⁄16" letter Side-to-side file bars (2)	3813⁄16" legal Side-to-side file bars (2)

K Fundamental

Pricing

Specifying Tips:

Counterweight kit, specified separately, is required for all individual freestanding units.

➤ See page 111.

Lock cores for key specific option must be specified separately.

➤ See page 113.

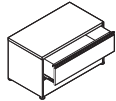

Two-High Lateral Files

- Two drawers
- Two side-to-side file bars per drawer
- 18"D x 27¹/₄"H

How to Specify:

- ① Model:
QFND18302 = 30"W
QFND18362 = 36"W
QFND18422 = 42"W
- ② Pull:
E = Extended **R** = Rail
ARC462 = Arc, Cinder
- ③ Lock option:
KRB = Key random
KSB = Key specific (-\$21)
- ④ Finish price group:
STD = Group 1
- ⑤ Finish designator:
 ➤ See list at left.

Sample (base model underlined):

① ② ③ ④ ⑤
QFND18302 E KRB STD 462

Pricing:

QFND18302	\$750
QFND18362	\$815
QFND18422	\$878

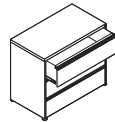

Three-High Lateral Files

- Three drawers
- Two side-to-side file bars per drawer
- 18"D x 39³/₁₆"H

How to Specify:

- ① Model:
QFND18303 = 30"W
QFND18363 = 36"W
QFND18423 = 42"W
- ② Pull:
E = Extended **R** = Rail
ARC462 = Arc, Cinder
- ③ Lock option:
KRB = Key random
KSB = Key specific (-\$21)
- ④ Finish price group:
STD = Group 1
- ⑤ Finish designator:
 ➤ See list at left.

Sample (base model underlined):

① ② ③ ④ ⑤
QFND18303 E KRB STD 462

Pricing:

QFND18303	\$876
QFND18363	\$996
QFND18423	\$1083

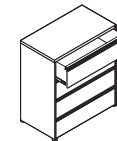

Four-High Lateral Files

- Four drawers
- Two side-to-side file bars per drawer
- 18"D x 51¹/₈"H

How to Specify:

- ① Model:
QFND18304 = 30"W
QFND18364 = 36"W
QFND18424 = 42"W
- ② Pull:
E = Extended **R** = Rail
ARC462 = Arc, Cinder
- ③ Lock option:
KRB = Key random
KSB = Key specific (-\$21)
- ④ Finish price group:
STD = Group 1
- ⑤ Finish designator:
 ➤ See list at left.

Sample (base model underlined):

① ② ③ ④ ⑤
QFND18304 E KRB STD 462

Pricing:

QFND18304	\$1065
QFND18364	\$1199
QFND18424	\$1353

K Fundamental

Pricing, continued

Specifying Tips:

Counterweight kit, specified separately, is required for all individual freestanding units.

➤ See page 111.

Lock cores for key specific option must be specified separately.

➤ See page 113.

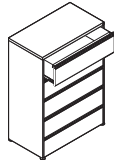

Five-High Lateral Files

- Five drawers
- Two side-to-side file bars per drawer
- 18"D x 64½"H

How to Specify:

- Model:
QFND18305 = 30"W
QFND18365 = 36"W
QFND18425 = 42"W
- Pull:
E = Extended **R** = Rail
ARC462 = Arc, Cinder
- Lock option:
KRB = Key random
KSB = Key specific (-\$21)
- Finish price group: **STD** = 1
- Finish designator:
 ➤ See list at left.

Sample (base model underlined):

QFND18305 ^① ^② ^③ ^④ ^⑤ E KRB STD 462

Pricing:

QFND18305	\$1426
QFND18365	\$1562
QFND18425	\$1708

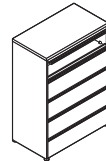

Five-High with Lift Door

- Four drawers
- Fixed shelf and lift door
- Two side-to-side file bars per drawer
- 18"D x 64½"H

How to Specify:

- Model:
QFND18305LD = 30"W
QFND18365LD = 36"W
QFND18425LD = 42"W
- Pull:
E = Extended **R** = Rail
ARC462 = Arc, Cinder
- Lock option:
KRB = Key random
KSB = Key specific (-\$21)
- Finish price group: **STD** = 1
- Finish designator:
 ➤ See list at left.

Sample (base model underlined):

QFND18305LD ^① ^② ^③ ^④ ^⑤ E KRB STD 462

Pricing:

QFND18305LD	\$1490
QFND18365LD	\$1624
QFND18425LD	\$1769



ADA Compliant Five-High Lateral Files

- Five drawers
- Two side-to-side file bars per drawer
- 18"D x 64½"H

How to Specify:

- Model:
QFND18305ADA = 30"W
QFND18365ADA = 36"W
QFND18425ADA = 42"W
- Pull:
R = Rail
ARC462 = Arc, Cinder
- Lock option:
KRB = Key random
KSB = Key specific (-\$21)
- Finish price group: **STD** = 1
- Finish designator:
 ➤ See list at left.

Sample (base model underlined):

QFND18305ADA ^① ^② ^③ ^④ ^⑤ R KRB STD 462

Pricing:

QFND18305ADA	\$1562
QFND18365ADA	\$1694
QFND18425ADA	\$1842

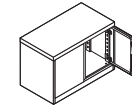

Overfile

- For use on top of lateral file or storage cabinet
- 18"D x 29¼"H

How to Specify:

- Model:
QFND1830OF = 30"W
QFND1836OF = 36"W
QFND1842OF = 42"W
- Lock option:
KRB = Key random
KSB = Key specific (-\$21)
- Finish type:
 Finish price group: **STD** = 1
- Finish designator:
 ➤ See list at left.

Sample (base model underlined):

QFND1830OF ^① ^② ^③ ^④ KRB STD 462

Pricing:

QFND1830OF	\$666
QFND1836OF	\$699
QFND1842OF	\$756

Pricing, continued

Specifying Tips:

Shelves are specified separately as required, and are field installed.

➤ See page 111.

Lock cores for key specific option must be specified separately.

➤ See page 113.

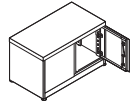

Two-High Storage Cabinets

- 18"D x 27¹/₄"H

How to Specify:

- Model:
QFND18302SC = 30"W
QFND18362SC = 36"W
QFND18422SC = 42"W
- Lock option:
KRB = Key random
KSB = Key specific (-\$21)
- Finish price group:
STD = Group 1
- Finish designator:
 ➤ See list at left.

Sample (base model underlined):

^① QFND18302SC ^② **KRB** ^③ **STD** ^④ 462

Pricing:

QFND18302SC	\$780
QFND18362SC	\$823
QFND18422SC	\$921

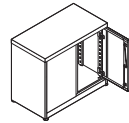

Three-High Storage Cabinets

- 18"D x 39³/₁₆"H

How to Specify:

- Model:
QFND18303SC = 30"W
QFND18363SC = 36"W
QFND18423SC = 42"W
- Lock option:
KRB = Key random
KSB = Key specific (-\$21)
- Finish price group:
STD = Group 1
- Finish designator:
 ➤ See list at left.

Sample (base model underlined):

^① QFND18303SC ^② **KRB** ^③ **STD** ^④ 462

Pricing:

QFND18303SC	\$823
QFND18363SC	\$864
QFND18423SC	\$961

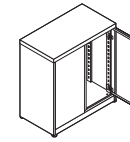

Four-High Storage Cabinets

- 18"D x 51¹/₈"H

How to Specify:

- Model:
QFND18304SC = 30"W
QFND18364SC = 36"W
QFND18424SC = 42"W
- Lock option:
KRB = Key random
KSB = Key specific (-\$21)
- Finish price group:
STD = Group 1
- Finish designator:
 ➤ See list at left.

Sample (base model underlined):

^① QFND18304SC ^② **KRB** ^③ **STD** ^④ 462

Pricing:

QFND18304SC	\$864
QFND18364SC	\$914
QFND18424SC	\$1012

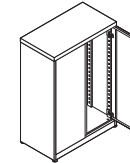

Five-High Storage Cabinets

- 18"D x 64¹/₂"H

How to Specify:

- Model:
QFND18305SC = 30"W
QFND18365SC = 36"W
QFND18425SC = 42"W
- Lock option:
KRB = Key random
KSB = Key specific (-\$21)
- Finish price group:
STD = Group 1
- Finish designator:
 ➤ See list at left.

Sample (base model underlined):

^① QFND18305SC ^② **KRB** ^③ **STD** ^④ 462

Pricing:

QFND18305SC	\$911
QFND18365SC	\$967
QFND18425SC	\$1065

Pricing, continued

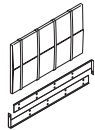

Counterweight Kit

- Required for freestanding files

How to Specify:

① Model:
QFNDACW = for any width file

Sample (base model underlined):

①
QFNDACW

Pricing:

QFNDACW \$164

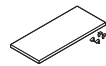

Overfile/Storage Cabinet Shelves

- Shelf is adjustable in 2" increments

How to Specify:

① Model:
QFND1830LFSHP = for 30"W unit
QFND1836LFSHP = for 36"W unit
QFND1842LFSHP = for 42"W unit

② Finish price group:

STD = Group 1

③ Finish designator:

➤ See list at left.

Sample (base model underlined):

① ② ③
QFND1830LFSHP STD 462

Pricing:

QFND1830LFSHP \$71
QFND1836LFSHP \$74
QFND1842LFSHP \$77



Wardrobe Kits

- For use with storage cabinets

How to Specify:

① Model:
QFND1830WB = for 30"W unit
QFND1836WB = for 36"W unit
QFND1842WB = for 42"W unit

Sample (base model underlined):

①
QFND1830WB

Pricing:

QFND1830WB \$63
QFND1836WB \$69
QFND1842WB \$71