



Statement of Line



➤ See page

Overview	101
Filing Capabilities	102

Options:

All available options on Kwik Office models are listed on the individual pricing pages.

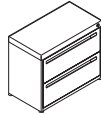

Two-High Lateral Files

- Two standard-height drawers
- See page 103.



Three-High Lateral Files

- Three standard-height drawers
- See page 103.

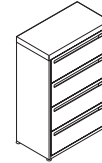

Four-High Lateral Files

- Four standard-height drawers
- See page 103.

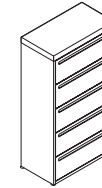

Five-High Lateral Files

- Five standard-height drawers
- Four standard-height drawers and one roll-out shelf with lift door.
- See page 104.



Counterweight Kits

- See page 104.



Overview

Details:

Drawers feature a built-in, anti-rebound catch to prevent drawer from accidentally rolling open.

Top is finished so the file can be used as a stand alone unit.

Knockouts are standard for ganging side by side.

Roll-out shelf with lift door (in applicable five-high models) replaces top drawer and adds 1" to overall height of the file. Accommodates standing binders up to 12"H.

Counterweight kit, specified separately, is required for all individual freestanding units. Kits include counterweight and bracket, packaged individually.

Four glides, standard, provide 3/4" adjustability and allow for sturdy, four-point loading.

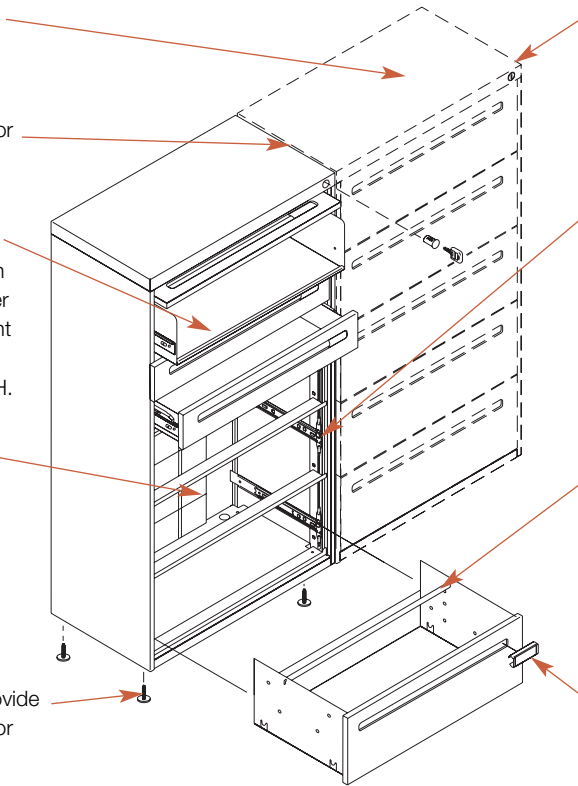

Heavy-gauge frame is reinforced at all corners and built into the front of the file so openings are always true and square.

Full ball-bearing drawer suspension allows both the drawer and suspension to extend together.

Side-to-side file bar is standard; one per drawer.

Front-to-back file bars are available separately for easy field installation.

Label holder is standard; one per drawer.

Features

Right angle bend of the coach seam makes the strongest use of formed metal and presents a clean exterior with no exposed welds.

Progressive-slide suspension provides smooth drawer operation.

Steel drawer interiors are pre-painted cinder.

Silencing bumpers ensure quiet drawer operation and are added to suspension wherever a steel-to-steel contact would otherwise be made.

Pulls:

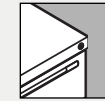

Drawer pull is recessed along the full front edge.

Locks:

Lateral files are predrilled to accept lock cores. Lock secures all drawers in the unit. Select key random or key specific when specifying.

Keying:

Key Random Option
Key numbers will be assigned arbitrarily at the factory with key numbers ranging from QKSCD001 to QKSCD025. Locks are shipped separately for field installation.

Key Specific Option
Specify any key number between QKSCD001 and QKSCD025. Locks are shipped separately for field installation.

IMPORTANT: If you select the key specific option, you must specify the lock core separately.
➤ See page 113.



LF Series

Filing Capabilities

Filing Reference:





- Legal size paper is 8½" x 14".
- Letter size paper is 8½" x 11".
- EDP size paper is 8½" x 14⅞".

Filing Hardware:

Heavier lines in the illustrations at right indicate filing hardware.

Front-to-back file bars can be specified separately.
 ▶ See page 112.

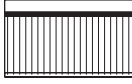
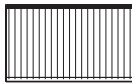
Side-to-side file bar is standard; one per drawer.
 ▶ See page 112.

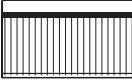
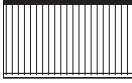
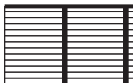
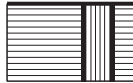
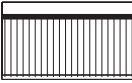
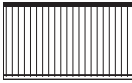
Description	Inside Depth	Inside Width	Height	Filing Inches and Arrangements			
18"D x 30"W lateral	14⅞"	26⅞"	9⅝"	 29⅝" letter Front-to-back file bars (2) Side-to-side file bar (1)	 25¼" legal Front-to-back file bar (1) Side-to-side file bar (1)	 26 ¹³ / ₁₆ " letter Side-to-side file bar (1)	 26 ¹³ / ₁₆ " legal Side-to-side file bar (1)
18"D x 36"W lateral	14⅞"	32⅞"	9⅝"	 29⅝" letter Front-to-back file bars (2) Side-to-side file bar (1)	 29⅝" legal Front-to-back file bars (2) Side-to-side file bar (1)	 32 ¹³ / ₁₆ " letter Side-to-side file bar (1)	 32 ¹³ / ₁₆ " legal Side-to-side file bar (1)
18"D x 42"W lateral	14⅞"	38⅞"	9⅝"	 44 ⁷ / ₁₆ " letter Front-to-back file bars (2) Side-to-side file bar (1)	 35⅝" legal Front-to-back file bars (2) Side-to-side file bar (1)	 38 ¹³ / ₁₆ " letter Side-to-side file bar (1)	 38 ¹³ / ₁₆ " legal Side-to-side file bar (1)



LF Series

Pricing

Specifying Tips:

Counterweight kit, specified separately, is required for all individual freestanding units.

➤ See page 104.

Lock cores for key specific option must be specified separately.

➤ See page 113.

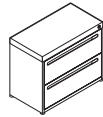

Two-High Lateral Files

- Two standard-height drawers
- One side-to-side file bar per drawer
- 18"D x 25¾"H

How to Specify:

- Model:
QLFF18302 = 30"W
QLFF18362 = 36"W
QLFF18422 = 42"W
- Pull:
F = Full pull
- Lock option:
KRB = Key random
KSB = Key specific (-\$21)
- Base:
X = No additional base
- Finish price group:
STD = Group 1
- Finish designator
➤ See list at left.

Sample (base model underlined):

QLFF18302 ^① ^② ^③ ^④ ^⑤ ^⑥ F KRB X STD 462

Pricing:

QLFF18302	\$828
QLFF18362	\$940
QLFF18422	\$993

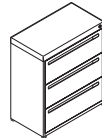

Three-High Lateral Files

- Three standard-height drawers
- One side-to-side file bar per drawer
- 18"D x 37¼"H

How to Specify:

- Model:
QLFF18303 = 30"W
QLFF18363 = 36"W
QLFF18423 = 42"W
- Pull:
F = Full pull
- Lock option:
KRB = Key random
KSB = Key specific (-\$21)
- Base:
X = No additional base
- Finish price group:
STD = Group 1
- Finish designator
➤ See list at left.

Sample (base model underlined):

QLFF18303 ^① ^② ^③ ^④ ^⑤ ^⑥ F KRB X STD 462

Pricing:

QLFF18303	\$1126
QLFF18363	\$1307
QLFF18423	\$1425

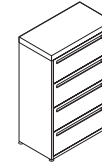

Four-High Lateral Files

- Four standard-height drawers
- One side-to-side file bar per drawer
- 18"D x 48¼"H

How to Specify:

- Model:
QLFF18304 = 30"W
QLFF18364 = 36"W
QLFF18424 = 42"W
- Pull:
F = Full pull
- Lock option:
KRB = Key random
KSB = Key specific (-\$21)
- Base:
X = No additional base
- Finish price group:
STD = Group 1
- Finish designator
➤ See list at left.

Sample (base model underlined):

QLFF18304 ^① ^② ^③ ^④ ^⑤ ^⑥ F KRB X STD 462

Pricing:

QLFF18304	\$1430
QLFF18364	\$1662
QLFF18424	\$1851



LF Series

Specifying Tips:

Counterweight kit, specified separately, is required for all individual freestanding units.

Lock cores for key specific option must be specified separately.

➤ See page 113.

Pricing, continued

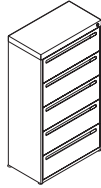

Five-High Lateral Files

- Five standard-height drawers
- One side-to-side file bar per drawer
- 18"D x 60 $\frac{1}{8}$ "H

How to Specify:

- Model:
QLFF18305 = 30"W
QLFF18365 = 36"W
QLFF18425 = 42"W
- Pull: **F** = Full pull
- Lock option:
KRB = Key random
KSB = Key specific (-\$21)
- Base: **X** = No additional base
- Finish price group:
STD = Group 1
- Finish designator
 ➤ See list at left.

Sample (base model underlined):

QLFF18305 ^① F ^② ^③ ^④ ^⑤ ^⑥ **KRB X STD 462**

Pricing:

QLFF18305	\$1777
QLFF18365	\$1956
QLFF18425	\$2142

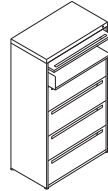

Five-High with Lift Door

- Four standard-height drawers
- Roll-out shelf with lift door
- One side-to-side file bar per drawer
- 18"D x 62 $\frac{1}{8}$ "H

How to Specify:

- Model:
QLFF18305LD = 30"W
QLFF18365LD = 36"W
QLFF18425LD = 42"W
- Pull: **F** = Full pull
- Lock option:
KRB = Key random
KSB = Key specific (-\$21)
- Base: **X** = No additional base
- Finish price group:
STD = Group 1
- Finish designator
 ➤ See list at left.

Sample (base model underlined):

QLFF18305LD ^① F ^② ^③ ^④ ^⑤ ^⑥ **KRB X STD 462**

Pricing:

QLFF18305LD	\$1851
QLFF18365LD	\$2029
QLFF18425LD	\$2216

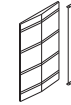

Counterweight Kit

- Required for freestanding files

How to Specify:

- Model:
QLFCW30 = for 30"W files
QLFCW36 = for 36"W files
QLFCW42 = for 42"W files

Sample (base model underlined):

^① QLFCW30

Pricing:

QLFCW30	\$168
QLFCW36	\$168
QLFCW42	\$168